



# Installing and operating the ILC 2050 BI and ILC 2050 BI-L Inline controllers

User manual

UM EN ILC 2050 BI

# User manual

## Installing and operating the ILC 2050 BI and ILC 2050 BI-L Inline controllers

UM EN ILC 2050 BI, revision 03

2021-06-10

---

This user manual is valid for:

Designation	Revision	Order No.
ILC 2050 BI		2403160
ILC 2050 BI-L		2404671
Emalytics	1.6	XXXXXXX

# Table of contents

1	Foreword .....	5
1.1	Purpose of this user manual .....	5
1.2	General safety notes.....	5
1.3	Intended use.....	6
1.4	Disposal .....	6
2	Description of the Inline controller .....	7
2.1	General description of the Inline controller.....	7
2.2	Processor core .....	7
2.3	Connection and operating elements.....	8
2.4	Diagnostic and status indicators.....	10
2.5	Internal basic circuit diagram .....	13
2.6	Interfaces.....	14
2.6.1	Ethernet .....	14
2.6.2	Serial interfaces .....	15
2.6.3	LON (ILC 2050 BI-L only) .....	16
2.6.4	USB .....	16
2.6.5	Inline local bus interface .....	17
2.6.6	WLAN interface (optional) .....	18
2.7	Software .....	19
2.7.1	System shell .....	19
2.7.2	I/O server .....	19
2.7.3	Startup website .....	20
2.7.4	Niagara daemon .....	20
2.8	Inline controller dimensions .....	20
2.9	Mounting and removing the Inline controller .....	21
2.10	Power supply.....	25
2.10.1	Calculating the power dissipation .....	28
2.10.2	Calculating the current consumption of an Inline station .....	29
2.10.3	Safety equipment, 24 V segment supply and 24 V main supply .....	30
3	Software for configuring the Inline controller .....	31
3.1	General information on software.....	31
3.2	Configuration tools .....	32
3.2.1	Protection against unauthorized access .....	32
3.2.2	System shell .....	33
3.2.3	Startup website .....	35
3.2.4	SFTP server .....	43
3.3	Startup.....	43
3.3.1	Assigning the IP address .....	43
3.3.2	Setting the time zone and time .....	44
3.3.3	Hardware data point test .....	45

3.4	Ethernet switch for flexible network topologies .....	46
3.4.1	Assignment of IP interfaces to external Ethernet interfaces .....	46
3.4.2	Ethernet ring monitoring .....	48
3.4.3	Rapid Spanning Tree Protocol (RSTP) .....	49
3.4.4	Interface status information .....	50
3.4.5	Broadcast storm avoidance .....	50
3.5	Integration with the Niagara Framework® .....	51
3.5.1	Local I/O access .....	51
3.5.2	Serial interfaces .....	53
3.5.3	Remote control of the Inline terminals .....	55
3.6	Concurrent access to the Inline terminals .....	56
4	Technical data and ordering data .....	58
4.1	Technical data .....	58
4.2	Ordering data ILC 2050 BI(-L) .....	61
A	Technical appendix.....	62
A 1	Fault avoidance .....	62
A 2	Diagnostics.....	64
A 3	Fault causes and remedies.....	65
A 4	Derating.....	67
B	Appendix for document lists.....	69
B 1	List of figures .....	69
B 2	List of tables .....	71
B 3	Index.....	73

# 1 Foreword

## 1.1 Purpose of this user manual

This user manual will help you to start up and operate the Inline controller ILC 2050 BI (Order No. 2403160) and ILC 2050 BI-L (Order No. 2404671).

Hereinafter, this document uses the general term Inline controller.

## 1.2 General safety notes

Observe the country-specific installation, safety, and accident prevention regulations.

During startup and maintenance work, proceed in accordance with the five safety rules of DIN EN 50110-1. In general, the rules should be observed in the order indicated below:

- Disconnect safely
- Ensure power cannot be switched on again
- Verify safe isolation from the supply
- Ground and short circuit
- Cover or safeguard adjacent live parts

Once the work is complete, perform the above steps again in reverse order.

**NOTE: Property damage due to impermissible stress**

The IP20 degree of protection (IEC 60529 / EN 60529) requires that the device be used in a clean and dry environment. If you use the device outside of the specified limits, this may cause damage to the device.

- Do not subject the device to mechanical or thermal stress that exceeds the specified limits.

**NOTE: Risk of unauthorized network access**

Connecting devices to a network via Ethernet always entails the risk of unauthorized access to the network.

Therefore, please check your application for any option of deactivating active communication channels (e.g., SNMP, SFTP, BootP, DCP) or setting passwords to prevent third parties from accessing the controller without authorization and modifying the system.

Because of the controller's communication interfaces, we advise against using the controller in safety-critical applications without additional security appliances.

Please take additional protective measures in accordance with the IT security requirements and the standards applicable to your application (e.g. virtual networks (VPN) for remote maintenance access, firewalls, etc.) for protection against unauthorized network access.

On first request, you agree to release Phoenix Contact and the companies associated with Phoenix Contact GmbH & Co. KG, Flachsmarktstraße 8, 32825 Blomberg, Germany, in accordance with §§ 15 ff. AktG or the German Stock Corporation Act (hereinafter collectively referred to as "Phoenix Contact") from all third-party claims made due to improper use.

For the protection of networks for remote maintenance via VPN, Phoenix Contact offers the mGuard product series of security appliances, which you can find described in the latest Phoenix Contact catalog ([phoenixcontact.net/products](https://phoenixcontact.net/products)).

Additional measures for protection against unauthorized network access can be found in the AH EN INDUSTRIAL SECURITY application note. The application note is available for downloading at [phoenixcontact.net/products](https://phoenixcontact.net/products).

### 1.3 Intended use

The Inline controller is a modular small-scale controller, which has been specially designed for automation applications in building infrastructure. The device corresponds to degree of protection IP20. The device is designed for use in closed control cabinets or control boxes (junction boxes) with IP54 degree of protection or higher.

The device is designed for use in building infrastructure and in industrial applications.

### 1.4 Disposal

- Do not dispose of the device with household waste; it should instead be disposed of in accordance with the currently applicable national regulations. It can also be returned to Phoenix Contact.

## 2 Description of the Inline controller

### 2.1 General description of the Inline controller



The ILC 2050 BI and ILC 2050 BI-L controllers look exactly the same, differing in just a few details and functions. Hereinafter, therefore, this document uses the general terms controller, bus controller, Inline controller, or ILC 2050 BI (-L). Any specific differences are indicated in the corresponding sections of the text where necessary.

The ILC 2050 BI (-L) Inline controller is a modular small-scale controller for Niagara and Sedona. A special feature of the Inline controller is its scalability, which involves several aspects:

- **Scalable I/Os**

The Inline controller is a head station for the modular Inline terminal system. You can connect up to 63 Inline terminals to an Inline controller. To this end, a variety of terminal types is available, ranging from digital and analog inputs and outputs with different numbers of channels right through to function terminals for DALI, pulse width modulation, M-Bus, or serial interfaces.

- **Scalable software**

The Inline controller has been designed for use with the Niagara Framework® (hereinafter referred to as Niagara). Niagara applications, known as Niagara stations, are created with the Niagara Workbench software tool.

Niagara's modular nature means its applications are able to fulfil an incredibly wide range of completely different project-specific requirements. If necessary, it is also possible to program your own separate modules and use them in the application.

- **Scalable licensing**

The license model for Niagara is very flexible: a number of data points are licensed, which are integrated with the Inline controller.

The license packages are available as initial licenses (250/500/1250/5000/10,000 data points) or as upgrade licenses (500/1250/2500 data points).

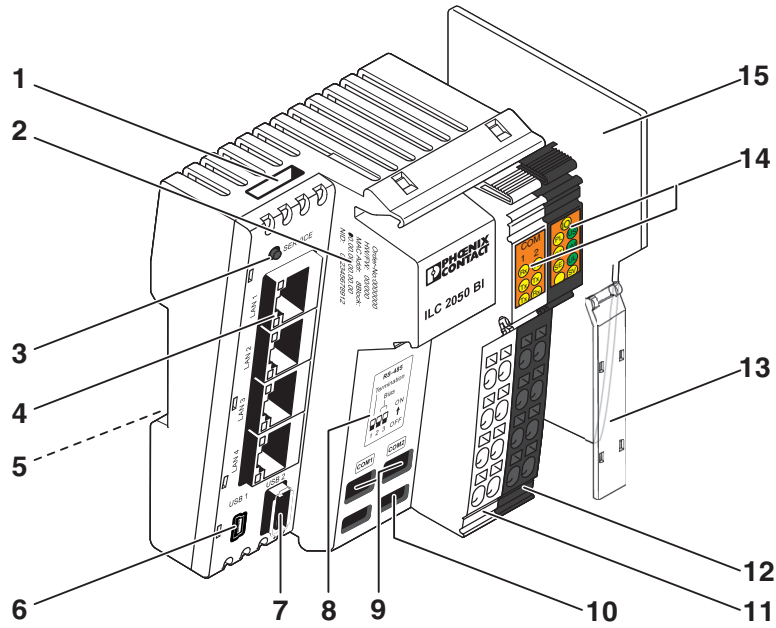
- **Scalable IP network**

The Inline controller has two IP interfaces that are logically separated from each other, and an integrated Ethernet switch with a total of four external interfaces. Thanks to the configurable assignment of Ethernet interfaces to the two IP interfaces that are separated from each other and the use of the spanning-tree protocol, flexible topologies such as daisy chains and redundant ring structures are possible in the backbone network and in the local controller network.

### 2.2 Processor core

- Processor: ARM® Cortex®-A8/1 GHz
- DDR3 SDRAM: 1 GB RAM (512 MiB for HW version <06, see series label)
- eMMC flash: 1.8 GB
- SRAM: 512 KiB (buffered for 5 days in the event of voltage failure)
- RTC: buffered for 5 days in the event of voltage failure

### 2.3 Connection and operating elements



107144A005

Figure 2-1 Structure of the Inline controller

**1** MicroSD card slot



The microSD card slot allows application-specific access to a removable medium for application- or user-specific use (user-specific JAVA programming required). The microSD card is not supplied as standard with the Inline controller. Please refer to the ordering data in [Section “Ordering data ILC 2050 BI\(-L\)” on page 61](#).

- 2** Imprint of the device-specific information
- 3** Service button
- 4** Ethernet interfaces (4 x 10/100Base-T)
- 5** Grounding contacts<sup>1</sup>
- 6** USB interface 1 (mini USB, USB OTG)
- 7** USB interface 2 (type A)
- 8** Assignment of DIP switches (RS-485 Termination/Bias)
- 9** DIP switches (RS-485 Termination/Bias)
- 10** Service interface
- 11** Connector 1: bus connector
- 12** Connector 2: power connector
- 13** Marking field (2x)
- 14** Diagnostic and status indicators
- 15** End plate

<sup>1</sup> On the rear device side, not visible in [Figure 2-1](#)



**RS-485 Termination/  
Bias**

RS-485 networks are executed in a bus topology and are terminated at both ends with a termination resistor between the data lines. Furthermore, the bus lines are brought once to a defined quiescent level with bias resistors. The Inline controller has resistor networks for termination (120 Ω) and quiescent potential setting (biasing of 510 Ω each) of the RS-485 networks connected with COM1 or COM2 according to BACnet MS/TP specifications. Each individual resistor can therefore be separately switched on via DIP switch.

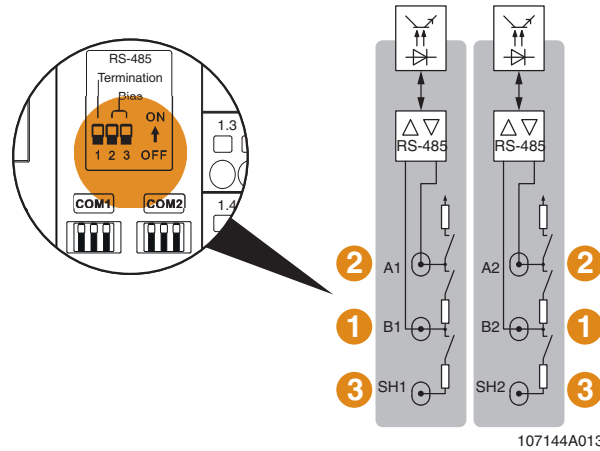


Figure 2-2 Assignment of DIP switches for RS-485 termination

## 2.4 Diagnostic and status indicators

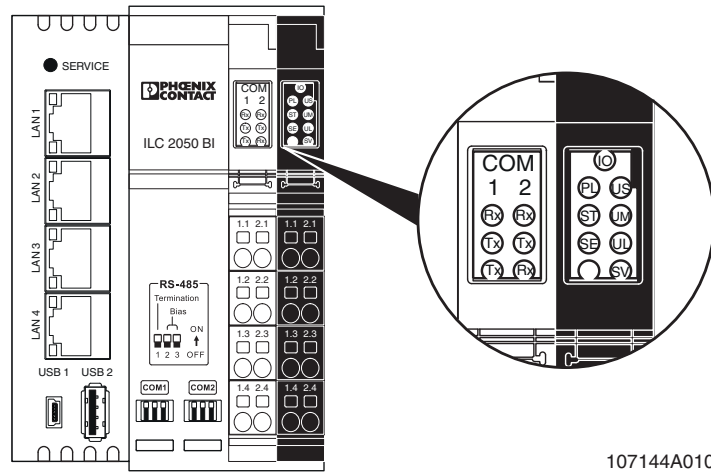


Figure 2-3 Diagnostic and status indicators

107144A010

Table 2-1 Diagnostic and status indicators

Des.	Color	Status	Meaning
<b>Supply LEDs</b>			
<b>US</b>	Green	Off	No voltage present in the segment circuit.
		On	Voltage present in the segment circuit (+24 V DC).
<b>UM</b>	Green	Off	No voltage present in the main circuit.
		On	Voltage present in the main circuit (+24 V DC).
<b>UL</b>	Green	Off	U <sub>BK</sub> (24 V supply), U <sub>L</sub> (logic circuit) not OK
		On	U <sub>BK</sub> (24 V supply), U <sub>L</sub> (logic circuit) not OK
<b>Process status LEDs</b>			
<b>PL</b>	Yellow	Status of the Niagara platform	
		Off	The process has not started.
		Flashing with 2 s cycle duration, 10% (on): 90% (off)	The process is running and requires less than 10% of the processor time.
		Flashing with 2 s cycle duration, 50% (on): 50% (off)	The process is running and requires between 10% and 50% of the processor time.
		Flashing with 2 s cycle duration, 90% (on): 10% (off)	The process is running and requires more than 50% of the processor time.

Table 2-1 Diagnostic and status indicators [...]

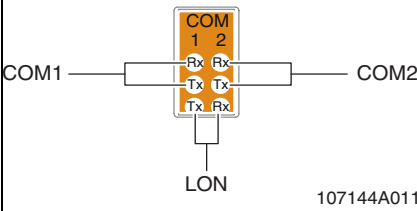
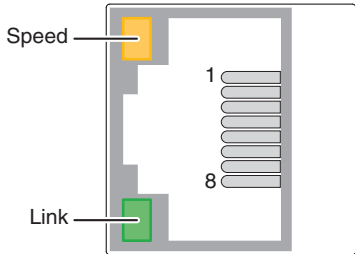
Des.	Color	Status	Meaning	
ST	Yellow	Status of the Niagara application		
		Off	The process has not started.	
		Flashing with 2 s cycle duration, 10% (on): 90% (off)	The process is running and requires less than 10% of the processor time.	
		Flashing with 2 s cycle duration, 50% (on): 50% (off)	The process is running and requires between 10% and 50% of the processor time.	
SE	Yellow	Status of the I/O server		
		Off	The process has not started.	
		Flashing with 2 s cycle duration, 10% (on): 90% (off)	The process is running and requires less than 10% of the processor time.	
		Flashing with 2 s cycle duration, 50% (on): 50% (off)	The process is running and requires between 10% and 50% of the processor time.	
PL, ST, and SE	Yellow	Running light		
		Off	The process has not started.	
		Flashing with 2 s cycle duration, 10% (on): 90% (off)	The process is running and requires less than 10% of the processor time.	
		Flashing with 2 s cycle duration, 90% (on): 10% (off)	The process is running and requires more than 50% of the processor time.	
<b>I/O status LED</b>				
IO		Status of communication with the Inline terminals		
	Green	On	Communication with the Inline terminals is error-free.	
	Yellow	On	Communication with the Inline terminals is interrupted. It is possible that no Inline terminals have been attached or that the Inline terminals are not correctly snapped in.	
<b>Communication LEDs</b>				
COM1, COM2, LON		Data traffic of the respective interface		
				
	COM1 Rx	Green	On	Data is being received via COM1.
	COM1 Tx	Yellow	On	Data is being sent via COM1.
	COM2 Rx	Green	On	Data is being received via COM2.
	COM2 Tx	Yellow	On	Data is being sent via COM2.
	LON Tx	Yellow	On	Data is being sent via LON. (ILC 2050 BI-L only)
LON Rx	Green	On	Data is being received via LON. (ILC 2050 BI-L only)	

Table 2-1 Diagnostic and status indicators [...]

Des.	Color	Status	Meaning
<b>Service LED</b>			
SV		Off	Normal operation and for approx. 7 s after applying the supply voltage
	Red	On	Inline controller boots; SV LED lights up for approx. 7 s
		Flashing at 5 Hz	SV LED flashes after booting for approximately 2 s, time window for manually resetting the IP address and the Niagara platform access data to default settings
	Green	Flashing at 5 Hz	After flashing red, the SV LED flashes green for approximately 2 s, time window for manually resetting the Sedona application and the Sedona kits to default settings
<p><b>Manual reset of the IP address, access data, and Sedona application</b></p> <p>The service button (see <a href="#">Section “Connection and operating elements” on page 8</a>) can be used together with the SV service LED to manually reset the IP address, Niagara platform access data, Daemon HTTP port, Daemon HTTPS port, and Sedona application to default settings.</p> <p>If the service button is pressed when the SV service LED is flashing red, and it is held for at least 3 s, the IP address of the eth0 IP interface and the Niagara platform access data are restored to default settings.</p> <p>If the service button is pressed when the SV service LED is flashing green, and it is held for at least 3 s, the Sedona application and the Sedona kits are restored to default settings.</p>			
<b>Ethernet status LEDs</b>			
Speed, Link		<p>Each Ethernet interface (LAN 1 ... LAN 4) has two LEDs that signal the connection and communication status of the interface.</p>  <p>10144A0</p>	
Speed	Yellow	Off	10 Mbps (if link is active)
		On	100 Mbps
Link	Green	Off	No electrical connection to network
		Briefly off	Package transmission
		On	Electrical connection to network

## 2.5 Internal basic circuit diagram

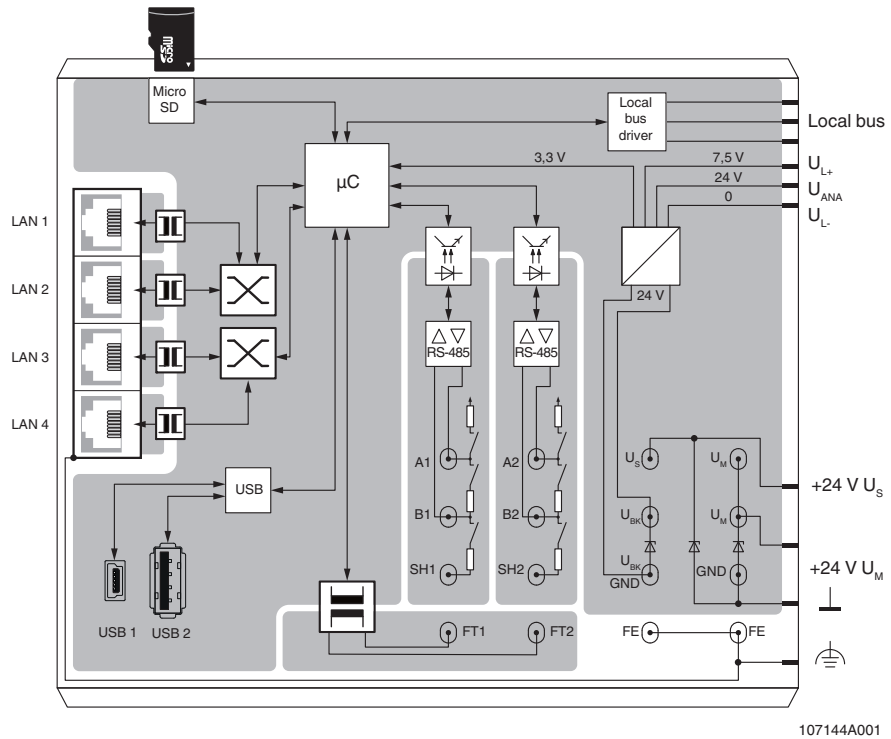









Figure 2-4 Internal basic circuit diagram

Key:

-  Ethernet switch
-  Microprocessor
-  Optocoupler
-  Converter
-  Inputs/outputs, shown as RS-485 driver (generator/receiver)
-  Transmitter
-  Electrically isolated areas



Other symbols used are explained in the IL SYS INST UM E user manual.

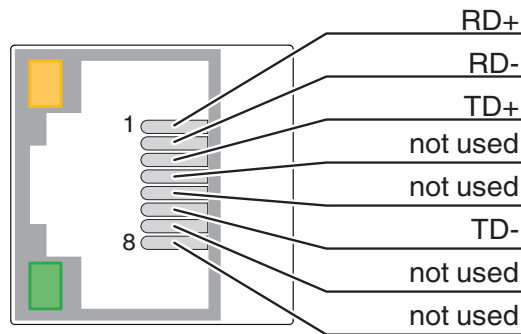
## 2.6 Interfaces

### 2.6.1 Ethernet

The integrated Ethernet switch has four external Ethernet interfaces, which can optionally be assigned to the two independent IP interfaces of the processor. In the delivery state, eth0 is connected to LAN 3 and LAN 4, and eth1 is connected to LAN 1 and LAN 2.

The Ethernet interfaces have the following properties:

- Shielded RJ45 ports
- 10/100Base-T, automatic detection
- Automatic MDI/MDI-X crossover detection



107144A008

Figure 2-5 Connection assignment of Ethernet interfaces

The Ethernet interfaces are able to detect and correct an interchanged receive path pair (RD+/RD-). This means you can use crossover and patch cables regardless of whether the remote station is a further end device or a switch or hub.



The maximum range of 100 m between Ethernet devices is only ensured if you use Ethernet cables that comply with at least CAT 5 of IEEE 802.3.  
Observe the bending radii of the Ethernet cables used.

## 2.6.2 Serial interfaces

The two RS-485 interfaces have switchable bias and termination resistors and are electrically isolated from each other and from the rest of the circuit.

The bus connector combines the connections for both RS-485 interfaces and the LON TP/FT-10 interface.

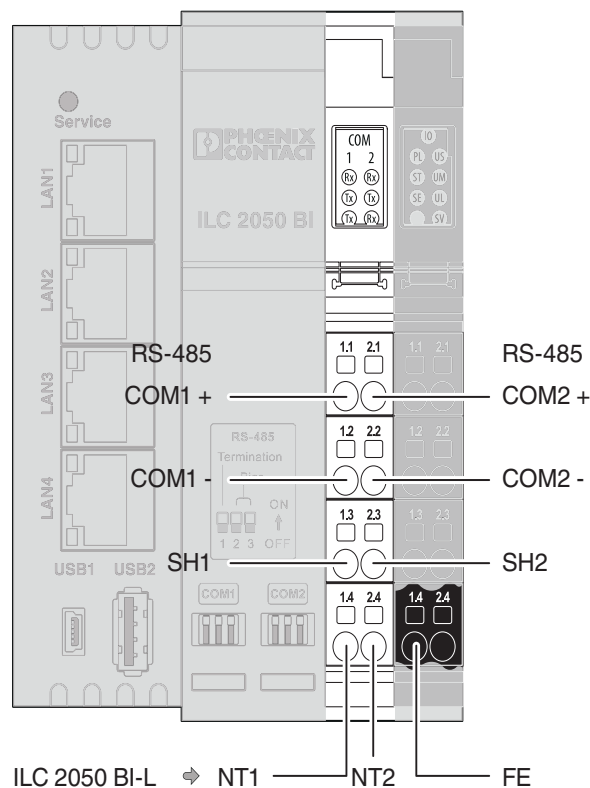


Figure 2-6 Connections of the bus connector

Table 2-2 Connection assignment of the bus connector

Terminal point	Designation	Function
1.1	COM1 +	COM1 RS-485 data signal + (positive)
1.2	COM1 -	COM1 RS-485 data signal - (negative)
1.3	SH1	COM1 shield connection
1.4	NT1	LON TP/FT-10 polarity-independent (ILC 2050 BI-L only)
2.1	COM2 +	COM2 RS-485 data signal + (positive)
2.2	COM2 -	COM2 RS-485 data signal - (negative)
2.3	SH2	COM2 shield connection
2.4	NT2	LON TP/FT-10 polarity-independent (ILC 2050 BI-L only)

For the RS-485 interfaces, you must observe the polarity of the data cables and the correct wiring of the network with termination and bias resistors. The Inline controller has corresponding resistors, which can be switched on via DIP switches. The connections of the shield connections to the FE connection (functional ground) are capacitive.

You can add further serial interfaces in the form of Inline terminals (Modbus, RS-232, RS-485, RS-422; see also [Section “Serial interfaces” on page 53](#)).

### 2.6.3 LON (ILC 2050 BI-L only)

The Inline controller (ILC 2050 BI-L only) has one LON interface in accordance with the CEA-709 standard for connecting to LON TP/FT-10 networks directly ([Figure 2-12](#)).

Ensure compliance with LonMark wiring guidelines ([www.lonmark.org](http://www.lonmark.org)) when connecting devices featuring LonWorks technology. Attach network terminators that correspond to the network topology.

If using shielded cables, you can connect the shield to the FE connection of the supply terminal to prevent a static charge developing. You do not have to take the polarity of the data cable into account here.

### 2.6.4 USB

#### 2.6.4.1 Mini USB interface

The USB OTG port with mini USB interface can be used for startup and maintenance. By connecting a PC, you can use the system shell and the startup website for device configuration and for the data point test.

USB OTG is used for local access. Local access takes the form of a connection between the Inline controller and a PC. The connection established via local access is independent from the device settings. Local access is established between the USB interface of a Windows® PC and the mini USB interface of the Inline controller using a USB cable.

#### Installing the PC driver software



With an operating system version 1.0.1.0 or higher [for the ILC 2050 BI(-L) controller], the necessary drivers are installed on the PC automatically (Windows 8.1, Windows 10). For older controller operating systems or Windows 7, the appropriate driver must be installed manually as follows:

The first time that the Inline controller is connected via USB, Windows® detects a new device and displays this in the device manager as “RNDIS/Ethernet Gadget” under “Other devices”. You must install the correct driver manually for this device. To do this, proceed as follows:

- In the local menu, select the device manager entry: “Update Driver Software”.



Local menu – including context menu, pop-up menu, or “right-click menu”. This user menu contains functions that relate to a specific GUI component – it is linked to a component in a particular context. The menu is opened by clicking on the component with the secondary mouse button (usually the one on the right) or using a function button.



- Select “Browse my computer for driver software”.
- Select “Let me pick from a list of device drivers on my computer”.
- For device type, select “Network Adapter”.
- As the manufacturer, select “Microsoft Corporation” and for network adapter, select “Remote NDIS Compatible Device” and then click “Next”.

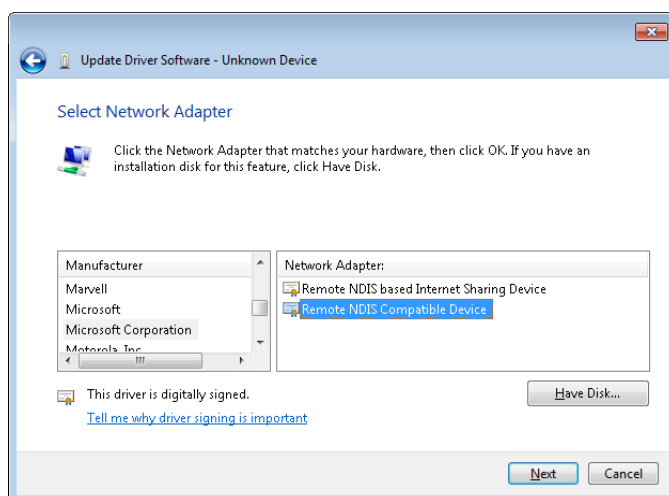


Figure 2-7 Selecting a network adapter

- Confirm the "Driver update" warning message that appears by clicking on "Yes".
- Close the message window after installing the device driver successfully.

The Inline controller is now classed as an “RNDIS/Ethernet Gadget” under Network Adapter. The PC then has another network connection that provides local network access to the Inline controller.

#### 2.6.4.2 USB type A interface

The USB type A interface is used to connect USB end devices that correspond to the USB 1.0 or USB 2.0 standard. Take note of the connection on the software side as well as the physical connection.

#### 2.6.5 Inline local bus interface

The Inline local bus interface enables up to 63 Inline terminals to be connected. It consists of the communication channel to the Inline terminals and the power supply to the Inline terminals as well as the connected sensors and actuators.

## 2.6.6 WLAN interface (optional)

The WLAN interface enables the integration of wireless network devices. It offers usage options of the Inline controller as an access point or as a network device (client).

The WLAN interface is added via USB WLAN dongle, which must be connected to the USB type A interface as described in section [2.6.4.2 “USB type A interface”](#).

Functionally, all USB WLAN adapters are equipped with a Realtek RTL8192CU chipset. These include the following devices:

- Belkin F7D1102de
- Belkin F7D2102de
- D-Link DWA-121
- D-Link DWA-123
- Edimax EW-7811Un
- TP-Link TL-WN821N-v4.1
- TP-Link TL-WN822N-v3
- TP-Link TL-WN823N-v1
- TP-Link TL-WN8200ND

The configuration of the WLAN interface is done via "Settings, WLAN" of the commissioning web page (described in section [3.2.3.2 ““Settings””](#), see also [Figure 3-9 on page 41](#)).

## 2.7 Software

A Linux operating system runs on the Inline controller, where multiple applications are executed in parallel.

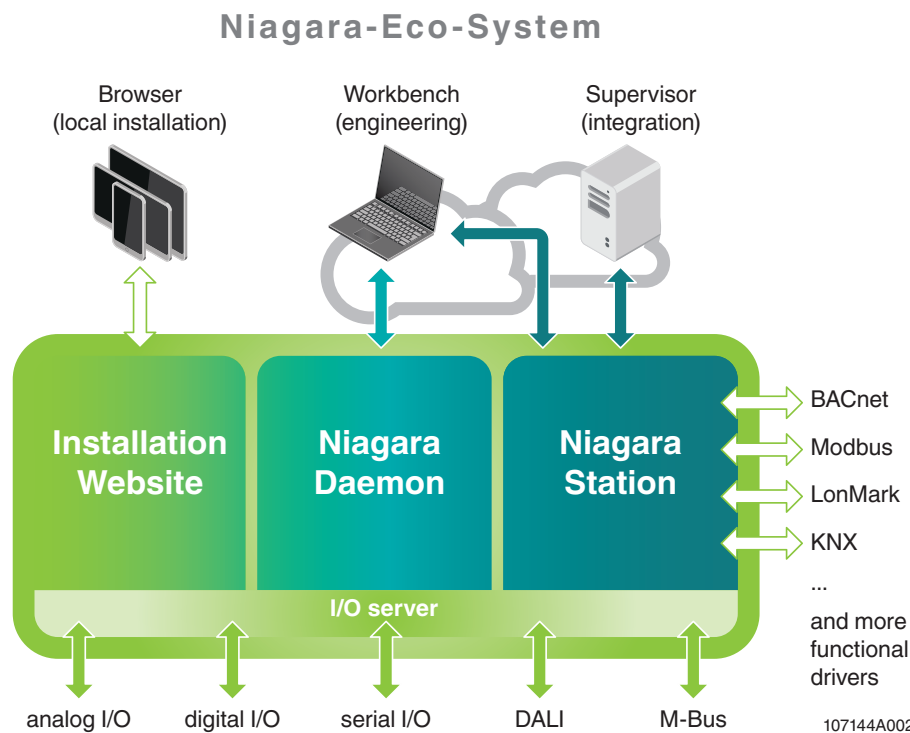


Figure 2-8 Structure of the Inline controller software

### 2.7.1 System shell

The system shell can only be reached via the local USB OTG port, and during startup it is used to set basic configuration data, such as the IP address. If you forget IP addresses or passwords, you can also use the system shell for service access.

### 2.7.2 I/O server

The I/O server controls the Inline terminals of the Inline controller and controls the competing access to hardware data points, where necessary. Communication between Niagara and the I/O server takes place via a TCP connection. This allows for remote control of the Inline terminals from another Niagara application. The remote controller can be restricted or deactivated via the IP address definition of the controlling Niagara application (see also [Section “Remote control of the Inline terminals” on page 55](#)).

### 2.7.3 Startup website

The startup website is only accessible via the local USB OTG port and is used to start up the Inline controller. Here you can set IP addresses, time zones, etc., and observe the hardware data points of the connected Inline terminals for test purposes as well as manually override them.

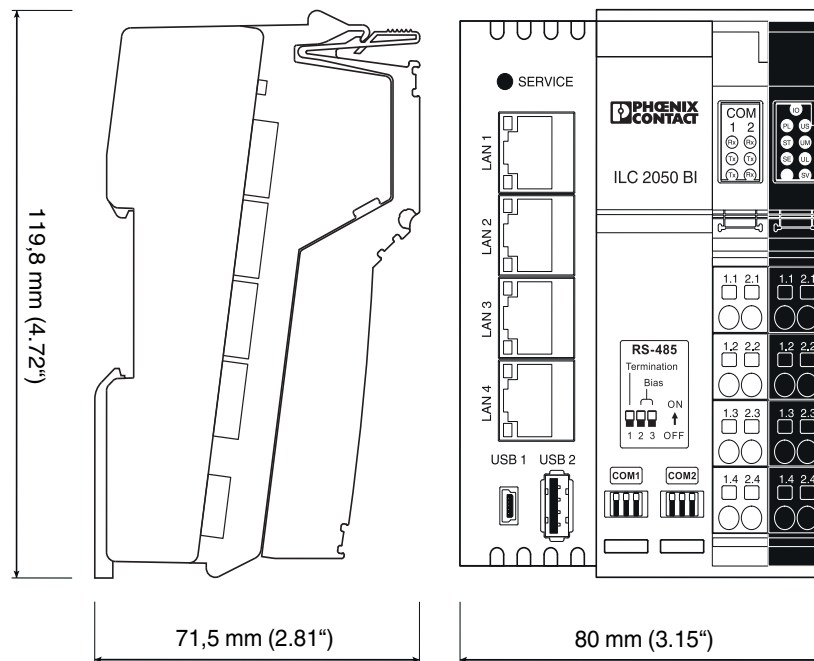
### 2.7.4 Niagara daemon

The Niagara daemon takes care of controller administration. With the Niagara Workbench and a platform connection to the Niagara daemon, you can configure the Inline controller and load software updates as well as a Niagara application (station). The Niagara application (station) can be started automatically by the Niagara daemon.

You can modify the application via an application connection to the Niagara Workbench. This allows you to use all the functions of the Niagara Framework®:

- Data point integration via a variety of (open) protocols (LON, BACnet, KNX, Modbus, and others) with data standardization
- System functions (time switch, alarms, trend recording)
- Web visualization
- Enterprise interfaces (oBIX, databases)
- ...

## 2.8 Inline controller dimensions



107144A003

Figure 2-9 Inline controller dimensions

## 2.9 Mounting and removing the Inline controller



**NOTE: Dangerous contact voltage**

During any work on the controller, switch off the power supply to the Inline station and make sure the supply voltage is protected against unauthorized reactivation.



For notes and instructions on mounting and removing Inline terminals, please refer to the IB IL SYS PRO UM E user manual (for INTERBUS), the IL SYS INST UM E Inline installation manual, or the Inline system manual for your bus system.

An Inline station is set up by mounting the individual components side by side. No tools are required. Mounting the components side by side automatically creates potential and bus signal connections between the individual station components.

The components are mounted perpendicular to the DIN rail.

### Mounting location

Like all other terminals in the Inline product range, the Inline controller has IP20 protection and is designed for use in a closed control cabinet or control box (junction box) with degree of protection IP54 or higher.

### DIN rail

The Inline controller is mounted on a 35 mm standard DIN rail.



Fix the DIN rail on which the Inline controller is mounted in several places, especially in the area around the Inline controller. This makes it easier to remove the Inline controller.

### End brackets

Mount end brackets on both sides of the Inline station. The end brackets ensure that the Inline station is correctly mounted. They secure the Inline station on both sides and keep it from moving from side to side on the DIN rail. Phoenix Contact recommends using CLIPFIX 35-5 end brackets (Order No. 3022276).

### End plate

The mechanical end of an Inline station is the end plate. It has no electrical function. It protects the station against ESD pulses and the user against dangerous contact voltages. The end plate is supplied with the Inline controller.



**NOTE: Risk of damage during mounting and removal if an Inline terminal is left in position**

When mounting or removing the Inline controller, it must be tilted. Tilting the Inline controller when mounting or removing it can damage the locking hooks and jumper contacts of the adjacent Inline terminal on the right.

- Before mounting or removing the Inline controller, detach the right-hand connector of the Inline controller and the adjacent Inline terminal on the right.

### Mounting position

Mount the Inline controller horizontally (as shown in [Figure 2-10 on page 22](#)). The temperature range specified in [Section "Ambient conditions" on page 60](#) is only guaranteed if the Inline controller is mounted in this position.



The Inline controller must only be mounted or removed within a temperature range from -25°C to +55°C.

**Mounting**

When mounting the Inline controller, proceed as shown in [Figure 2-10](#) and [Figure 2-11](#):

- Disconnect the station from the power supply.
- Place the Inline controller onto the rail from above ([Figure 2-10, A](#)), then push it onto the rail fully ([Figure 2-10, B](#)).
- Next, mount all the electronic bases that will be required to set up the Inline station. Observe the information provided in the aforementioned user manuals.



Ensure that **all** the springs and slots of adjacent Inline terminals interlock properly.

- Once you have mounted all the electronic bases, attach the relevant connectors to them.  
First, insert the front connector catch into the front latching mechanism ([Figure 2-11, A](#)). Then push the connector toward the electronic base until it engages in the rear latching mechanism ([Figure 2-11, B](#)).

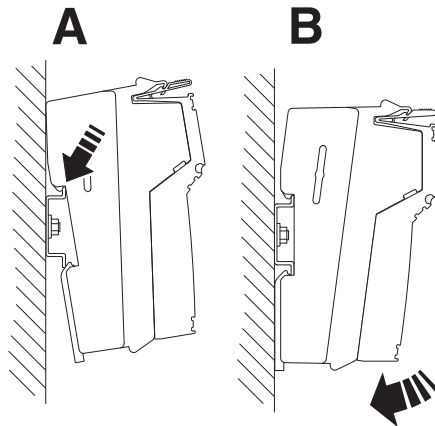


Figure 2-10 Mounting the Inline controller (1)

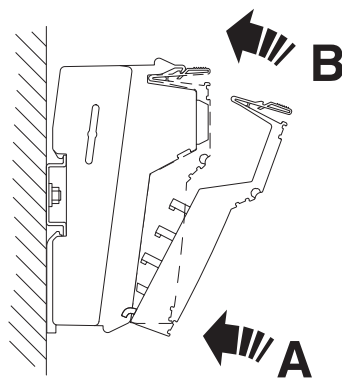


Figure 2-11 Mounting the Inline controller (2)

## Removal

When removing the Inline controller from the DIN rail, proceed as shown in [Figure 2-13](#):

- Disconnect the Inline station from the power supply.



**NOTE: Risk of damage during mounting and removal if an Inline terminal is left in position**

When mounting or removing the Inline controller, it must be tilted. Tilting the Inline controller when mounting or removing it can damage the locking hooks and jumper contacts of the adjacent Inline terminal on the right.

- Before mounting or removing the Inline controller, detach the right-hand connector of the Inline controller and the adjacent Inline terminal on the right.
- Detach all the connectors from the Inline controller.
  - Lever each of the connectors out by pressing on the rear connector catch ([Figure 2-13, A](#)).
  - Detach the connectors ([Figure 2-13, B](#)).
- If Inline terminals are mounted on the Inline controller (see [Figure 2-12](#)):
  - Detach the following connectors:
    - All connectors of the Inline terminal that are connected directly (A1 to A4)
    - The adjacent connector of the subsequent Inline terminal (B1).
  - Remove the directly adjacent Inline terminal (A).



Observe the information provided in the user manuals mentioned on [page 21](#).

- Insert a tool in the base latches of the Inline controller and pull gently upwards ([Figure 2-14, A](#)). Pull out the Inline controller from the DIN rail ([Figure 2-14, B, C](#)).

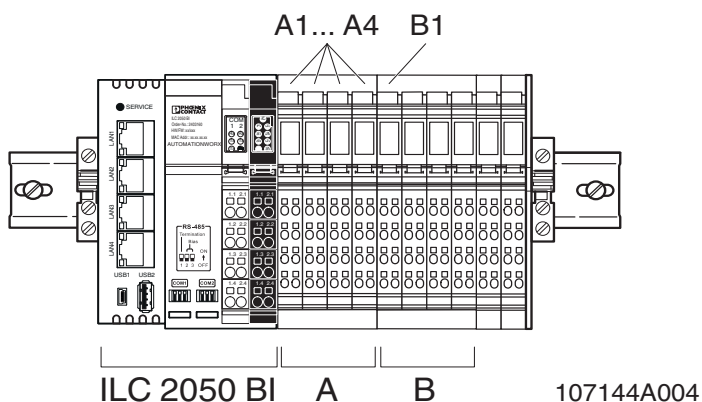


Figure 2-12 Connectors to be removed when Inline terminals are attached

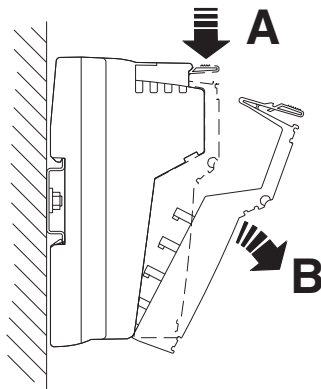


Figure 2-13 Removing the Inline controller (1)

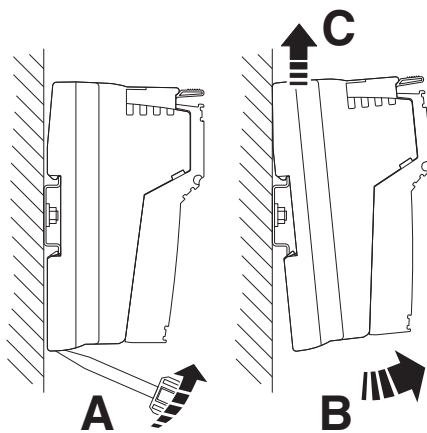


Figure 2-14 Removing the Inline controller (2)

**Replacing an Inline controller**

If you want to replace an Inline controller within an Inline station, proceed as described above (mounting and removing). Make sure to remove the adjacent Inline terminal on the right both when removing and mounting the Inline controller. Only attach this Inline terminal again when the Inline controller has been mounted.



Take special care to ensure that **all** the springs and slots of adjacent Inline terminals interlock properly.



Observe the following when replacing an Inline controller:

- If you are using the BootP server, enter the new MAC address.



## 2.10 Power supply

The Inline controller is operated using a 24 V DC voltage. From this 24 V DC, the Inline controller generates the logic voltage for the logic circuit and the analog voltage for the analog circuit. The logic circuit supplies power to the internal bus, including the communications chips of all connected Inline terminals. The analog circuit supplies an auxiliary voltage for analog signals.

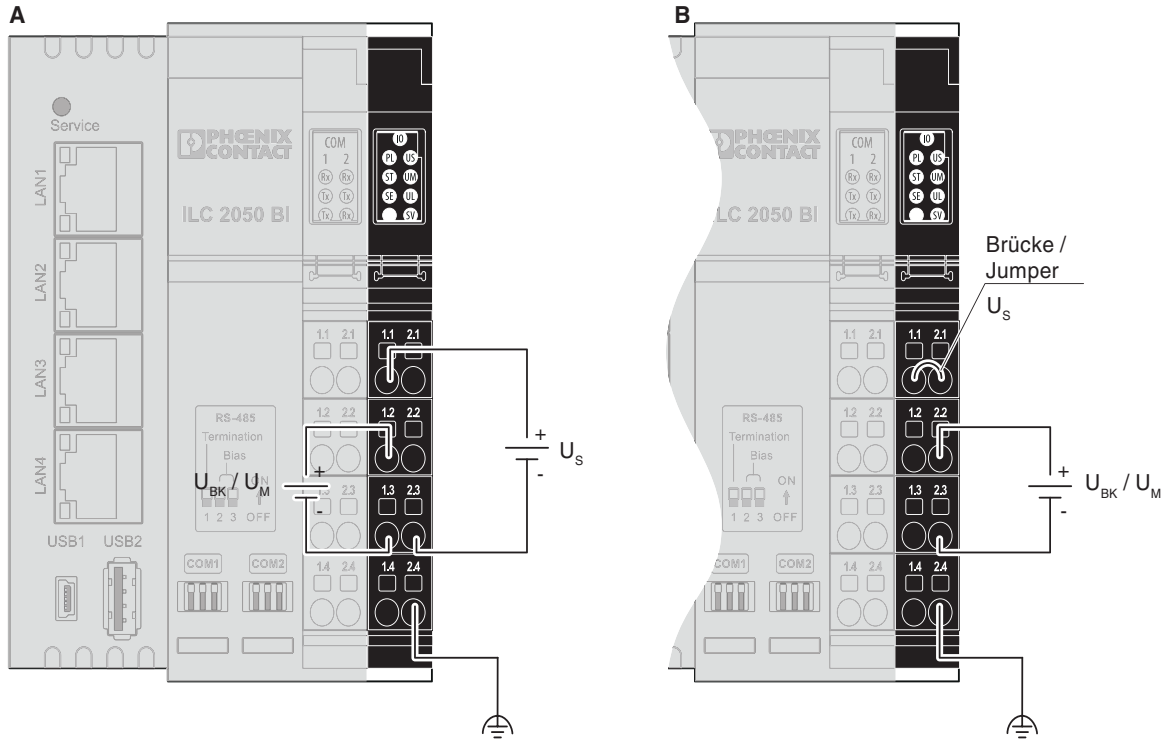
**WARNING: Danger of device failure due to thermal overload**

- Observe the derating of the logic supply and the supply to the analog Inline terminals when connecting the Inline terminals, as well as the maximum current carrying capacity of the Inline terminals.

For more information on derating, please refer to [Section “Derating” on page 67](#).

Furthermore, the Inline controller has connections to supply power to the main and segment voltage of the Inline station.

Figure 2-15 shows the basic circuit diagram for the connection of supply voltages.



107144A009

Figure 2-15 Supply  $U_M/U_{BK}$  and  $U_S$  from different voltage sources (A) and from one common voltage source (B)

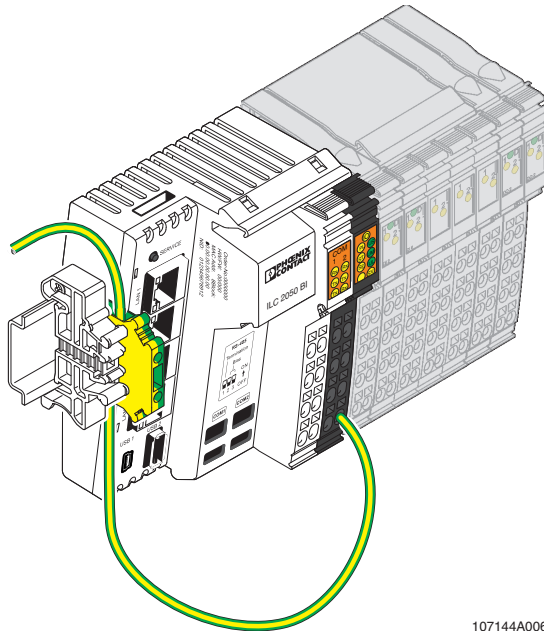
**WARNING: Danger of device failure due to thermal overload**

- Ensure that the current flowing through the Inline terminals and potential jumpers does not exceed 8 A.

If  $U_{BK}/U_M$  and  $U_S$  are supplied with power from a common source, you must ensure the individual areas are adequately protected in view of their power requirements.

FE functional ground is routed to the potential jumpers. The Inline controller is grounded automatically when it is mounted onto a grounded DIN rail. The functional ground serves to discharge interference.

The functional ground connection (terminal points 1.4 and 2.4) must also be connected to the DIN rail using a 1.5 mm<sup>2</sup> conductor and a grounding terminal (see [Figure 2-16](#)).



107144A006

Figure 2-16 Schematic view of functional ground of the Inline controller

Table 2-3 Connection assignment of the feed-in terminal

Terminal point	Designation	Function
1.1	$U_S$	24 V DC segment supply (segment circuit) The fed-in voltage is routed to the Inline terminals via the potential jumpers.
2.1 1.2, 2.2	$U_{BK}/U_M$	$U_{BK}$ : 24 V DC supply to the Inline controller and feed to the logic circuit and analog circuit $U_M$ : 24 V DC main voltage (main circuit) The fed-in voltage is routed through the Inline terminals via the potential jumpers.
1.3, 2.3	GND	Reference ground for the internal bus and the Inline terminals (logic and analog circuit), as well as the main and segment supply (main and segment circuit).
1.4, 2.4	FE	Functional ground Functional ground must be connected to the 24 V power connector. The contacts are connected to the potential jumpers and the FE springs on the housing floor, so that when snapping onto a grounded DIN rail, the Inline controller is grounded.

### 2.10.1 Calculating the power dissipation

The power dissipation of the Inline controller is calculated from the auxiliary power consumption of the Inline controller and the power dissipation of the internal power supply unit, which supplies the USB interfaces and the entire Inline station with  $U_L$ :

$$P_{ILC} = P_O + P_{USB} + P_{PERI}$$

$P_{ILC}$  = Inline controller power dissipation

$P_O$  = Power input for operating the Inline controller with no Inline terminals connected (4.1 W)

$P_{USB}$  = Power dissipation of the Inline controller's power supply unit, depending on the current consumption of the loads at the USB 1 and USB 2 interfaces (max. 500 mA each)

$$P_{USB} = 0.7 \text{ V} \times (I_{USB1} + I_{USB2})$$

$$P_{PERI} = 1.0 \text{ V} \times I_L$$

$P_{PERI}$  = Power dissipation of the Inline controller's power supply unit, depending on the current consumption from  $U_L$  of the rest of the Inline station

$I_L$  = Overall current consumption of the Inline terminal from  $U_L$  (max. 2 A)



The factors 1.0 V and 0.7 V result from the degree of effectiveness of the internal power supply unit.

**Example calculation:**

Power dissipation of an Inline controller at a maximum possible current load of  $U_L$  and with a USB stick in the USB 2 interface with 0.1 A current consumption.

$$P_{ILC} = 4.1 \text{ W} + 0.7 \text{ V} \times 0.1 \text{ A} + 1.0 \text{ V} \times 2.0 \text{ A}$$

$$P_{ILC} = 4.1 \text{ W} + 0.07 \text{ W} + 2.0 \text{ W}$$

$$P_{ILC} = 6.17 \text{ W}$$

## 2.10.2 Calculating the current consumption of an Inline station

For power supply unit dimensioning, you must determine the current consumption of the entire Inline station. It is calculated using:

$$I_{IS} = I_{ILC} + I_{USB} + I_K + I_{AS}$$

- $I_{IS}$  = Current consumption of the entire Inline station
- $I_{ILC}$  = Power requirement of the Inline controller
- $I_{USB}$  = Power requirement of the connected USB devices
- $I_K$  = Power requirement of the connected Inline terminals
- $I_{AS}$  = Power requirement of the sensors and actuators supplied with power from the Inline station

The power requirement of the Inline controller without Inline terminals is approximately 170 mA at 24 V.

$$I_{ILC} = 0.17 \text{ A}$$

For the power required to supply the USB interfaces, refer to the data sheet for the connected USB device.

The USB current  $I_{USB1/2}$  is included in the overall current consumption with a factor of 0.24.

This results in the following formula:

$$I_{USB} = (I_{USB1} + I_{USB2}) \times 0.24$$

For the power requirements of the connected Inline terminals, refer to the respective data sheets. The following rules of thumb apply:

- The power required from  $U_{ANA}$  is included directly in the overall current consumption.
- The power required from  $U_L$  is included in the overall current consumption with a factor of 0.36.

This results in the following formula:

$$I_K = I_{An} + I_L \times 0.36$$

- $I_A$  = Current from  $U_{ANA}$  (max. 500 mA)
- $I_L$  = Current from  $U_L$  (max. 2.0 A)

For the current consumption of the connected actuators and sensors, refer to the respective data sheets. The current consumption is determined by the specific application.

In the interests of making an assessment, it will usually be sufficient to just check whether power can be supplied via the Inline controller, i.e., without power or boost terminals.

If no boost terminals are used and without taking the  $U_M$  and  $U_S$  circuits into account, the maximum current consumption of the Inline controller with Inline terminals connected is 1.7 A.

The power requirements of the actuators and sensors must be added to this figure, whereby the Inline terminals and potential jumpers restrict the maximum current to 8 A.



Please plan sufficient reserves when selecting the power supply unit. Also consider that input capacitance will cause a momentary current rise several times greater than the nominal current at the point of switch-on. Power supply units with overcurrent shutdown must offer a sufficient response delay to prevent starting problems.

### 2.10.3 Safety equipment, 24 V segment supply and 24 V main supply

**Surge voltage**

Segment and main supply are protected against surge voltage by input protective diodes, which can be destroyed in the event of continuous overload.

**Reverse polarity**

Segment and main supply are protected against reverse polarity by polarity protection diodes, which cause the upstream fuses to melt due to high current in the event of an error.

The segment supply and the main supply have the same reference potential.



Each 24 V area must be protected externally. The power supply unit must be able to supply four times the nominal current of the external fuse; this is to ensure that it trips the fuse in the event of an error.

## 3 Software for configuring the Inline controller

### 3.1 General information on software

A Linux operating system runs on the Inline controller, where multiple applications are executed in parallel. The Inline controller is configured and programmed via the Niagara Workbench.

Table 3-1 Software settings in the Inline controller delivery state

Ethernet:	eth0 - LAN 3 / LAN 4	IP address 192.168.1.1 Subnet mask 255.255.255.0
	eth1 - LAN 1 / LAN 2	Disabled
Login details for the Niagara platform:	User: sysmik Password: intesa	

## 3.2 Configuration tools

### 3.2.1 Protection against unauthorized access

The configuration of basic device settings is sensitive and must be protected from unauthorized access. To prevent unauthorized access from the network while providing stable access for configuration to the Inline controller, independent of the IP settings, the Inline controller provides local access via USB OTG (see [Section “Mini USB interface” on page 16](#)).

Via the USB OTG connection, the connected PC receives a new virtual network adapter, which is connected to the Inline controller and is automatically addressed by the Inline controller via DHCP. In this virtual network, the Inline controller has the IP address 172.16.0.10.

Various protocols and services for configuration, startup, and diagnostics are available for the PC via the USB OTG connection,.

Table 3-2 Protocols via USB OTG

Protocol	Port	PC software	Application
Telnet	23	Telnet client	System shell
HTTP	8080	Web browser	Startup website



### 3.2.2 System shell

You can apply basic settings to the Inline controller via the system shell. To apply settings via the system shell, proceed as follows:

- Connect your PC to the Inline controller via USB OTG (see also [Section “Mini USB interface” on page 16](#)).
- Open the Telnet client on your PC.
- Establish a connection to the Inline controller's Telnet server on:
  - IP address: 172.16.0.10
  - Port: 23
- Click on “Open” to open the system shell.

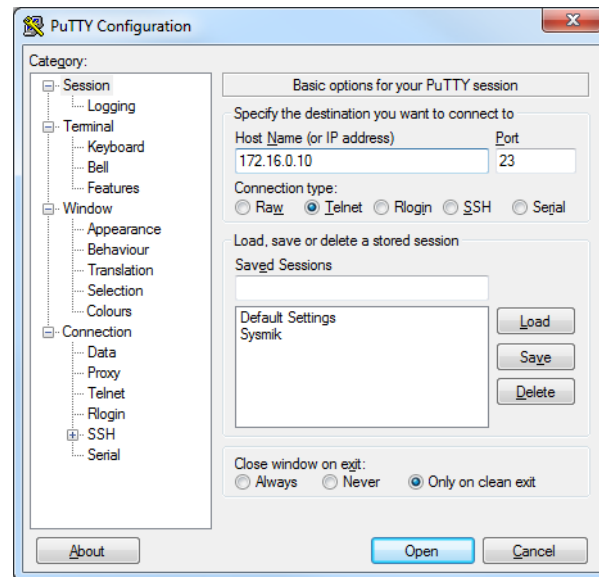


Figure 3-1 Telnet client (example): establishing a connection to the Telnet server

The system shell displays the host ID, version information for different software components, the current time, and IP address of the Inline controller and offers different actions in the form of a number menu.

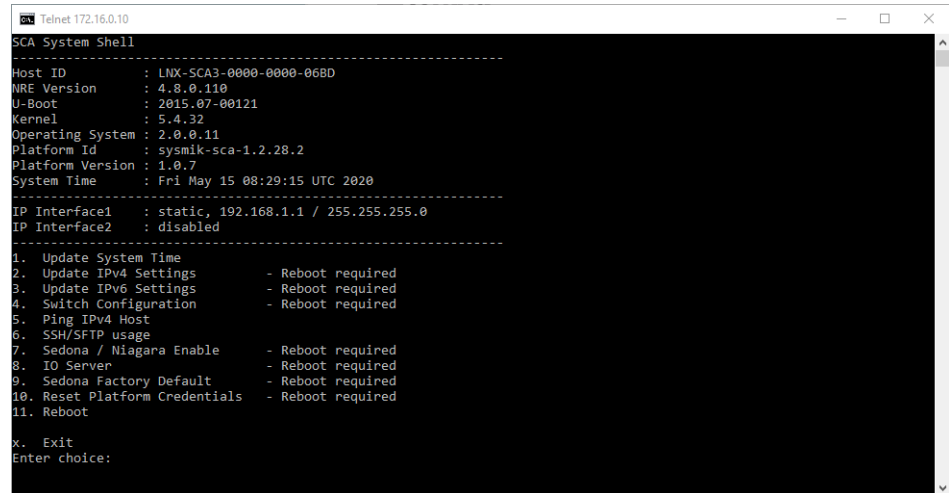


Figure 3-2 System shell (example)

- |                                |   |
|--------------------------------|---|
| 1. Update System Time          | For setting the current time  |
| 2. Update IPv4 Settings        | For setting IP addresses  |
| 3. Update IPv6 Settings        | For setting IPv6 addresses  |
| 4. Switch Configuration        | For configuring the Ethernet switch (assignment of Ethernet interfaces to IP interfaces, RSTP, ring monitoring, broadcast storm avoidance)                |
| 5. Ping IPv4 Host              | For pinging an IP address from the Inline controller  |
| 6. SSH/SFTP usage              | For starting and stopping the SSH/SFTP server   |
| 7. Sedona / Niagara Enable     | For activating/deactivating Niagara and Sedona  |
| 8. IO Server                   | For setting the I/O server (port number, remote address)  |
| 9. Sedona Factory Default      | Resets the Sedona application and kits to the delivery state  |
| 10. Reset Platform Credentials | Resets the access data for the Niagara platform to the delivery state (user: "sysmik", password: "intesa", daemon HTTP port 3011, daemon HTTPS port 5011) |
| 11. Reboot                     | Restarts the Inline controller  |
| x. Exit                        | Terminates the Telnet connection  |

### 3.2.3 Startup website

The startup website enables you to make device settings and access data points of connected Inline terminals. To apply settings via the startup website, proceed as follows:

- Connect your PC to the Inline controller via USB OTG (see also [Section “Mini USB interface” on page 16](#)).
- Open a web browser.
- Enter the following URL:  
172.16.0.10:8080

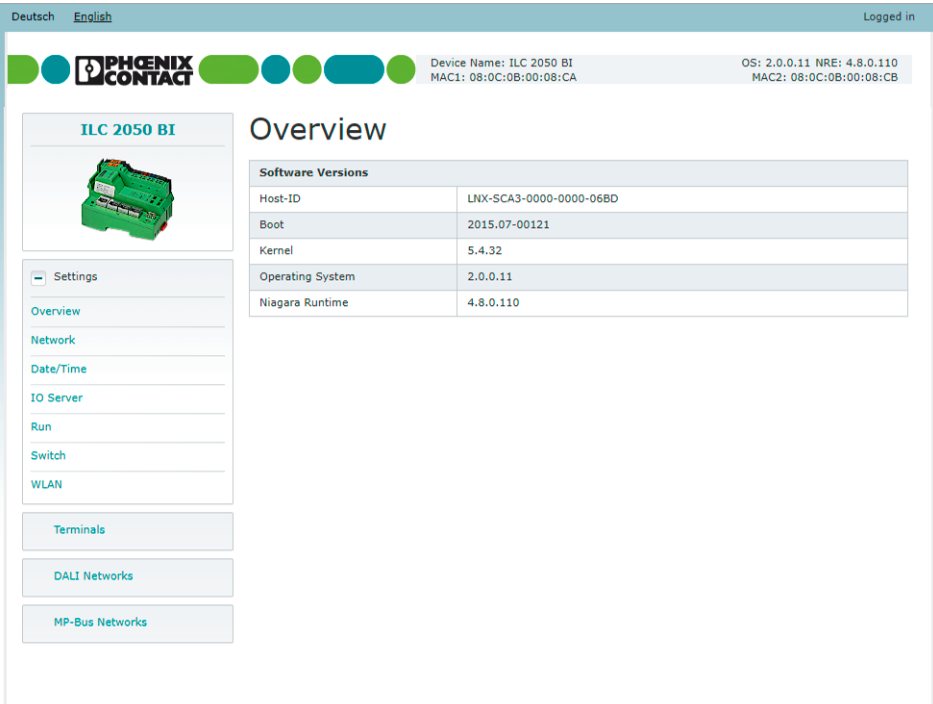
The startup website opens.

- To display the website in German, for example, click on the German flag.
- Click on “Login”.

The “Overview” page opens.

#### 3.2.3.1 “Overview”

On the “Overview” page, the host ID as well as the version numbers for various software components of the Inline controller are displayed.



The screenshot displays the web interface for the ILC 2050 BI controller. At the top, there are language options (Deutsch, English) and a 'Logged in' status. The main header includes the Phoenix Contact logo and device details: Device Name: ILC 2050 BI, MAC1: 08:0C:0B:00:08:CA, OS: 2.0.0.11, NRE: 4.8.0.110, and MAC2: 08:0C:0B:00:08:CB. The central content area is titled 'Overview' and features a 'Software Versions' table. On the left, a sidebar menu lists various settings categories like Overview, Network, Date/Time, IO Server, Run, Switch, and WLAN, along with buttons for Terminals, DALI Networks, and MP-Bus Networks. The footer contains copyright information: © 2017-2020 PHOENIX CONTACT Legal Information.

Software Versions	
Host-ID	LNX-SCA3-0000-0000-06BD
Boot	2015.07-00121
Kernel	5.4.32
Operating System	2.0.0.11
Niagara Runtime	4.8.0.110

Figure 3-3 Startup website: Overview

### 3.2.3.2 “Settings”

Under “Settings”, you can apply device settings:

- “Network” for setting the IP addresses
- “Date/Time” for setting the current time and time zone
- “IO Server” for setting the I/O server (port number, remote address)
- “Run” for activating/deactivating Niagara or Sedona
- “Switch” for configuring the internal Ethernet switch
- „WLAN“ for configuration of wireless networks

#### “Settings, Network”

On the “Settings, Network” page, you can change the connection parameters of the two Ethernet interfaces (Interface 1 and Interface 2 in [Figure 3-4](#)).

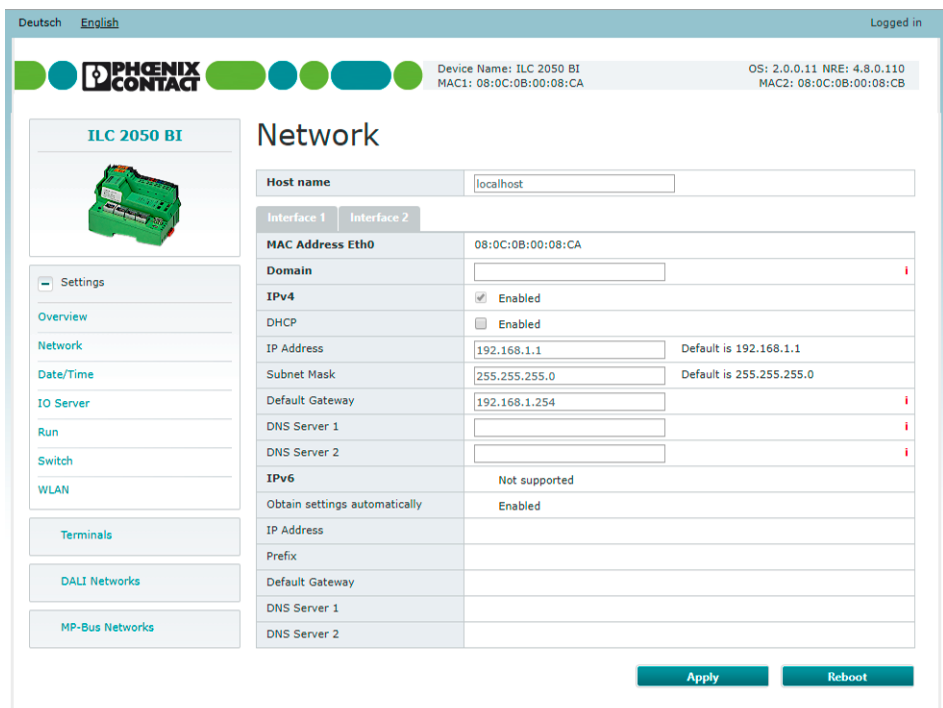


Figure 3-4 Startup website: “Settings, Network”

**“Settings, Date/Time”**

On the “Settings, Date/Time” page, you can set the date, time, time zone, and IP address of the SNTP time server.

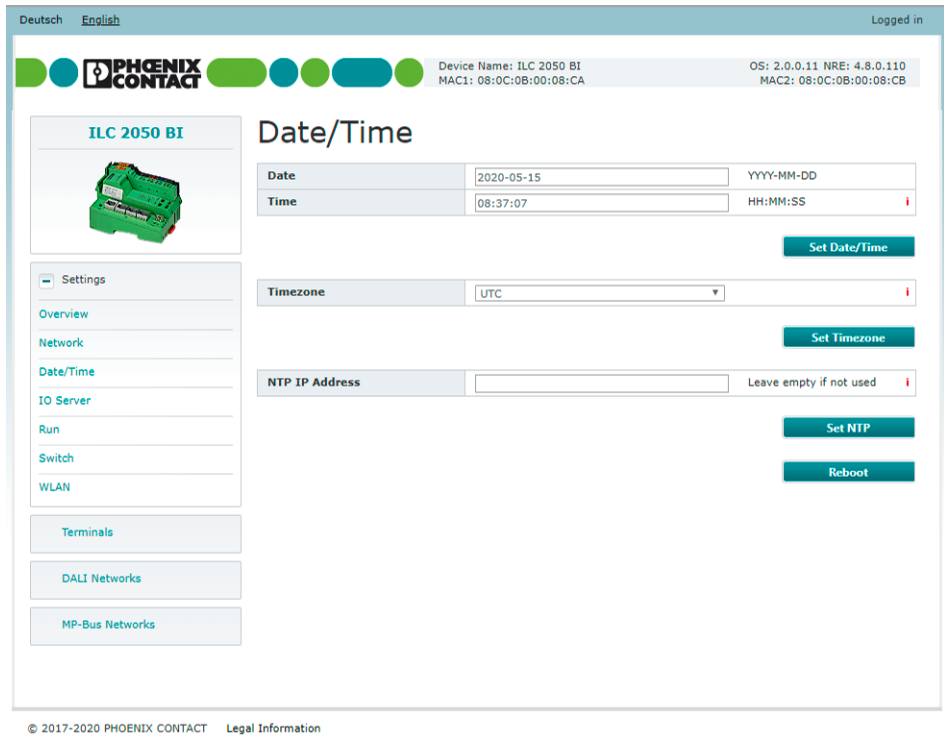


Figure 3-5 Startup website: “Settings, Date/Time”

### “Settings, IO Server”

On the “Settings, IO Server” page, enter the “IO Server Port” (default setting: 2015) as well as the “IO Server Remote Address”. The “IO Server Remote Address” is the IP address of the Inline controller, which is permitted to control the inputs and outputs of the Inline controller at hand. With the IP address “255.255.255.255”, every Inline controller can control inputs and outputs.

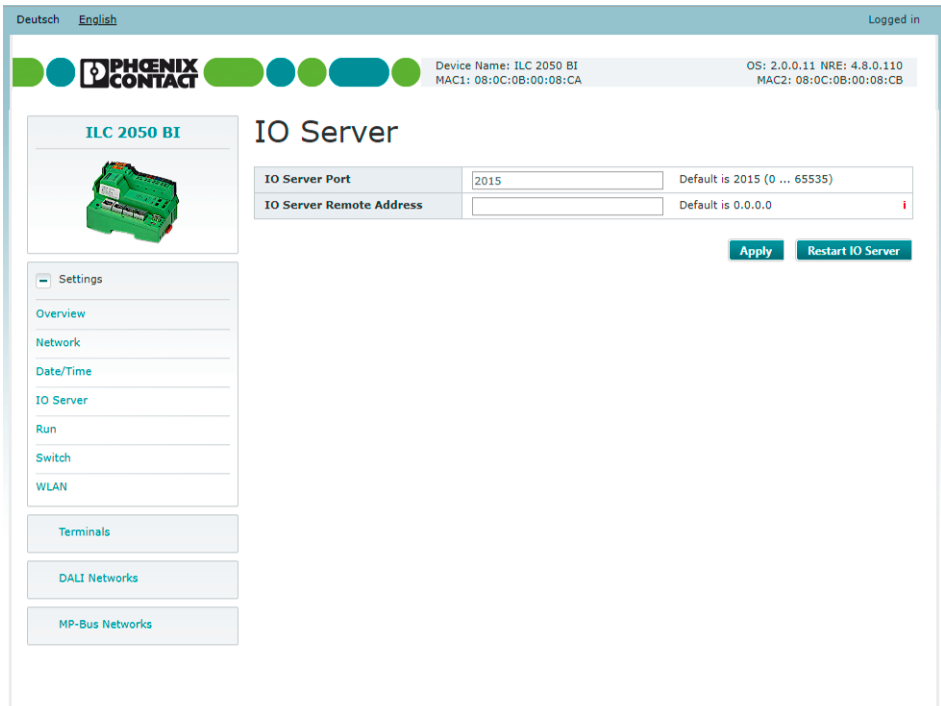


Figure 3-6 Startup website: “Settings, IO Server”

### “Settings, Run”

On the “Settings, Run” page, you can activate or deactivate Niagara and/or Sedona. Here you also have the option to carry out a reboot.

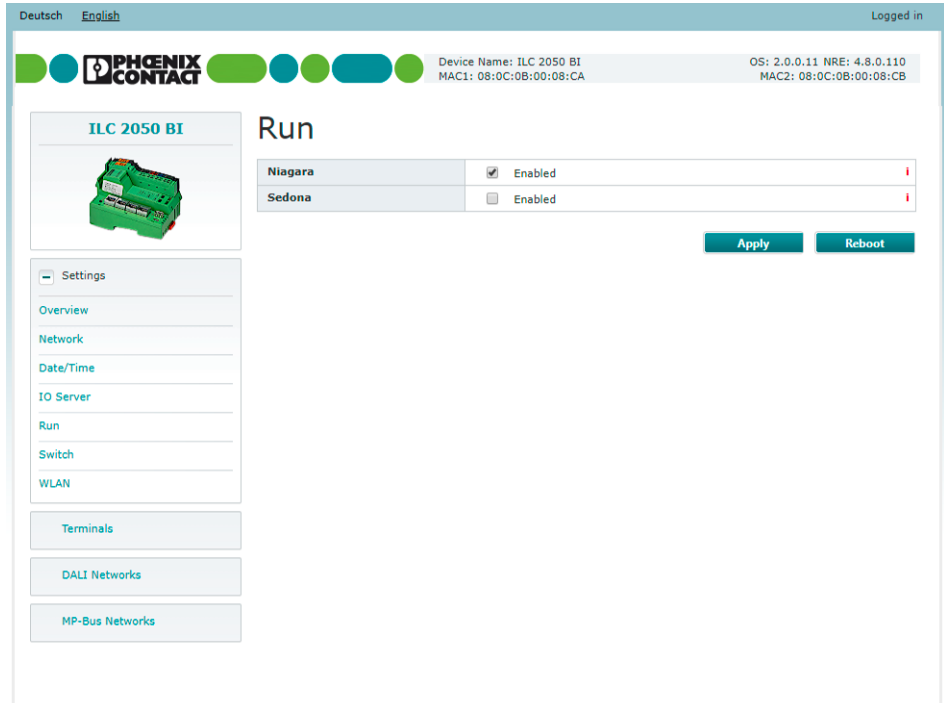
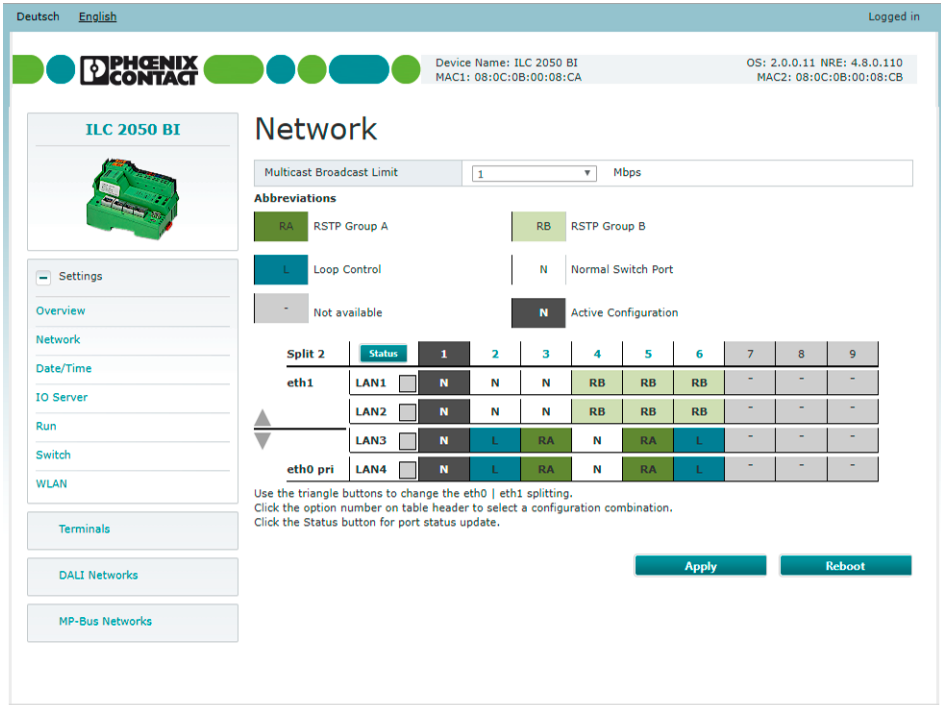


Figure 3-7 Startup website: “Settings, Run”

“Settings, Switch”

On the “Settings, Switch” page, you can configure the internal Ethernet switch. This includes assigning the external Ethernet interfaces to the internal IP interfaces of the controller, activating RSTP or ring monitoring, and setting the parameters for avoiding broadcast storms.



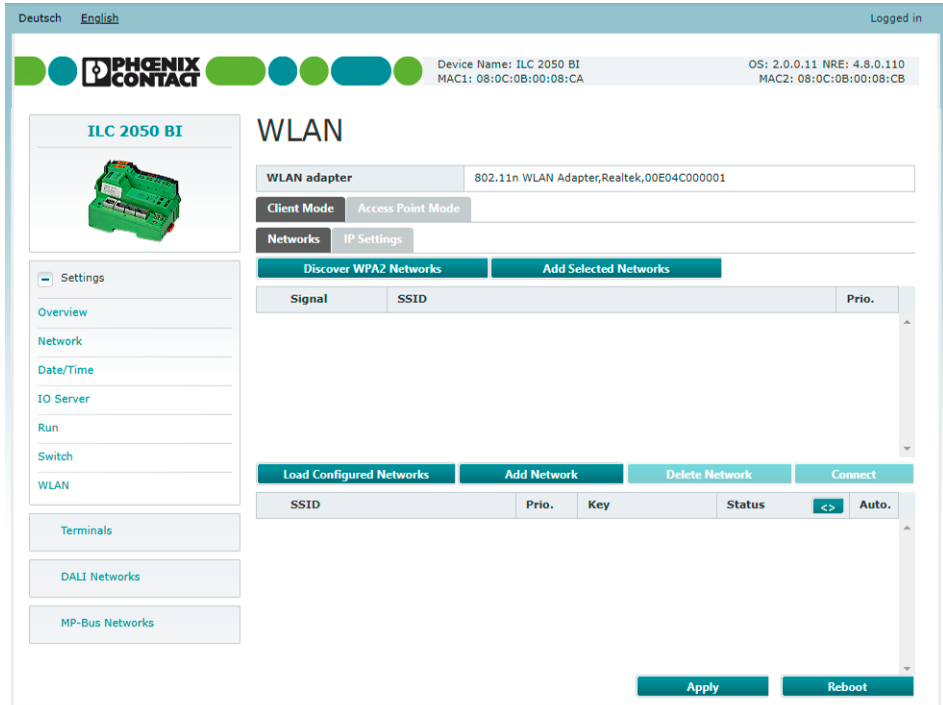
© 2017-2020 PHOENIX CONTACT Legal Information

Figure 3-8 Startup website: “Settings, Switch”



„Settings, „WLAN“

On the "Settings, WLAN" page, you can configure the operating modes of the WLAN adapter, as well as its properties. This also includes searching for available networks and managing them.



© 2017-2020 PHOENIX CONTACT Legal Information

Figure 3-9 Startup website: „Settings, WLAN“

### 3.2.3.3 “Terminals”

On the “Terminals” page, you can see all the connected Inline terminals. You can manually override the Inline terminals for data point tests (see [Section “Hardware data point test” on page 45](#)).

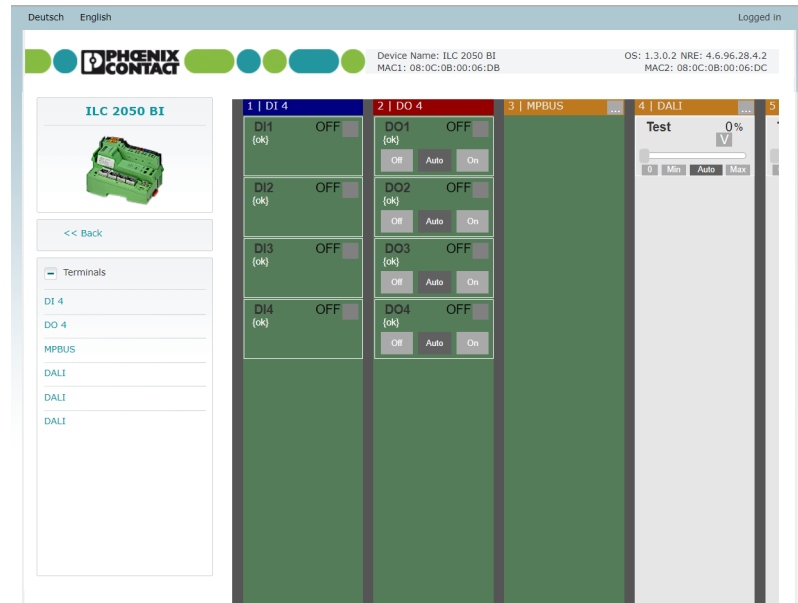


Figure 3-10 Startup website: “Terminals”

### 3.2.3.4 Other webservice websites

The webservice hosts other websites, which can also be reached via Ethernet as an alternative:

- DALI configurator for addressing and parameterizing DALI networks that are connected to the Inline controller via DALI terminals.
- User-defined visualization pages, that can be created in the Sedona programming environment.
- MP-Bus configurator for addressing and parameterizing MP-Bus networks that are connected to the Inline controller via MP-Bus terminals.

### 3.2.4 SFTP server

#### File access via SFTP

The Inline controller has an SFTP server for accessing the file system. Software updates, for example, can be downloaded from the PC to the Inline controller in this way. The SFTP server can only be activated and deactivated via the SCA system shell (see [Section 3.2.2](#)).

A password can be set for user “sftpuser” to facilitate this access. SSH access can be activated in parallel to SFTP. Only the device manufacturer can use this to diagnose the controller based on command lines.

## 3.3 Startup

In the delivery state, the Inline controller has a standard configuration. Settings such as IP address, time, and time zone must be specifically defined.

The following software components of the Inline controller are active in the delivery state:

- The system shell waits for inputs.
- The I/O server detects the connected Inline terminals and opens its interfaces for the startup website and for Sedona and Niagara.
- The startup webserver hosts the startup website.
- The Niagara Daemon functions as a communication partner for a platform connection with the Niagara Workbench (user: “sysmik”, password: “intesa”). However, no application is running – you can load this as part of Niagara commissioning.

A change to the IP addresses or time zone is only completely effective following a restart of the Inline controller.

### 3.3.1 Assigning the IP address

The standard IP address of the first Ethernet interface (eth0) of the Inline controller is 192.168.1.1, the subnet mask is 255.255.255.0. The second Ethernet interface (eth1) is disabled in the delivery state. There are several ways of configuring the IP address:

- System shell (see [Section “System shell” on page 33](#))
- Startup website via “Settings, Network” (see [Section 3.2.3](#))
- Niagara Workbench via platform connection to the Niagara Daemon under “TCP/IP Configuration”

### 3.3.2 Setting the time zone and time

The time is held in a buffered real-time clock (RTC). On delivery, the buffer capacitor is generally discharged. The clock begins to count when the Inline controller is first started up, showing 01.01.2000, 0:00. The time as well as the time zone (default setting: Central European Time or Central European Summer Time) can be set in different ways:

- System shell (see [Section “System shell” on page 33](#))
- Startup website via “Settings, Date/Time” (see [“Settings, Date/Time” on page 37](#))
- Niagara Workbench via platform connection to the Niagara Daemon under “Platform Administration, Change Date/Time”

### 3.3.3 Hardware data point test

Often, the hardware startup and the software startup take place separately, both in terms of time and personnel. Ideally, the electrical installation work (installation and cabling) is completed with a data point test and corresponding handover certificate. You can use the startup webserver to perform the data point test. Here, all input and output signals of the Inline terminals are clearly displayed. If required, you can manually override outputs and terminal parameters, such as measuring ranges, per channel. Thus, a data point test is possible, even without application software. When logging out of the startup website (manually or following timeout), all overrides are automatically canceled.

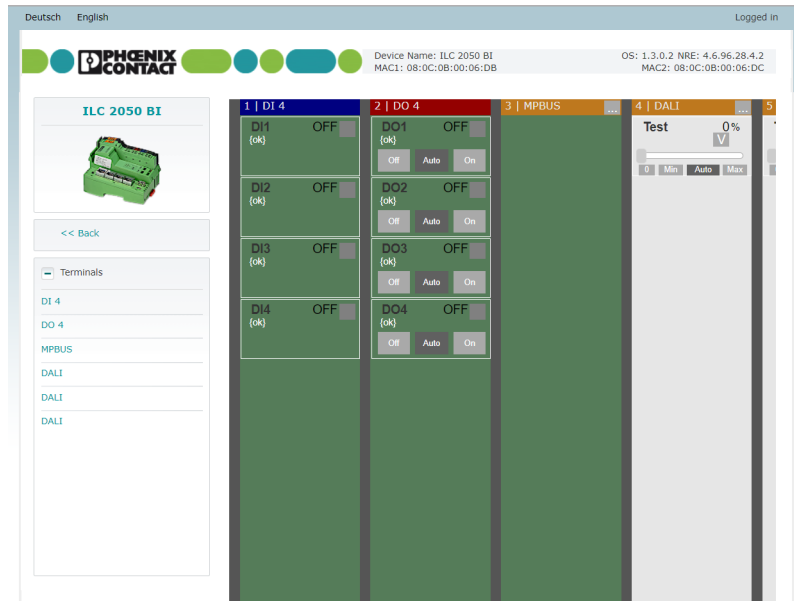


Figure 3-11 Data point test via the startup website

### 3.4 Ethernet switch for flexible network topologies

The integrated Ethernet switch with four external and two internal Ethernet interfaces facilitates Ethernet cabling without additional switches. It supports:

- The optional assignment of IP interfaces to external Ethernet interfaces
- A ring monitoring function with automatic port shutdown
- The Rapid Spanning Tree Protocol (RSTP) for managing redundant Ethernet topologies
- The limitation of Ethernet communication in order to avoid multicast and broadcast storms

The Ethernet switch is configured via the following access points:

- System shell (see [Section “System shell” on page 33](#))
- Startup website (see [Section “Startup website” on page 35](#))
- Niagara Workbench via Fox connection to the Niagara application under “Config, Drivers, SysmikScaloNetwork, LocalPlatform, EthSwitch (SysmikScaSwitchCfgView)”

When using the ring monitoring function and RSTP, the interface status (deactivated, deactivated) of the Ethernet interfaces concerned changes automatically. The interface status information provides insight into the condition of the redundant topology. The status of the external Ethernet interfaces is shown in the Niagara application, in the Sedona application, and on the startup website for analysis purposes.

Delivery state:

- RSTP deactivated
- Ring monitoring function deactivated
- Broadcast/multicast limitation 1 Mbps
- eth1 at LAN 1, LAN 2
- eth0 at LAN 3, LAN 4

#### 3.4.1 Assignment of IP interfaces to external Ethernet interfaces

The two internal IP interfaces eth0 and eth1 are routed to the four external Ethernet interfaces LAN 1 to LAN 4 via the Ethernet switch. See [Table 3-3](#) to [Table 3-6](#) for the possible combinations.

Table 3-3 LAN 1 ... 4 at eth0, eth1 is deactivated

LAN 1	eth0
LAN 2	
LAN 3	
LAN 4	

Table 3-4 LAN 2 ... 4 at eth0, LAN 1 at eth1

LAN 1	eth1
LAN 2	eth0
LAN 3	
LAN 4	

Table 3-5 LAN 3 ... 4 at eth0, LAN 1 ... 2 at eth1 (delivery state)

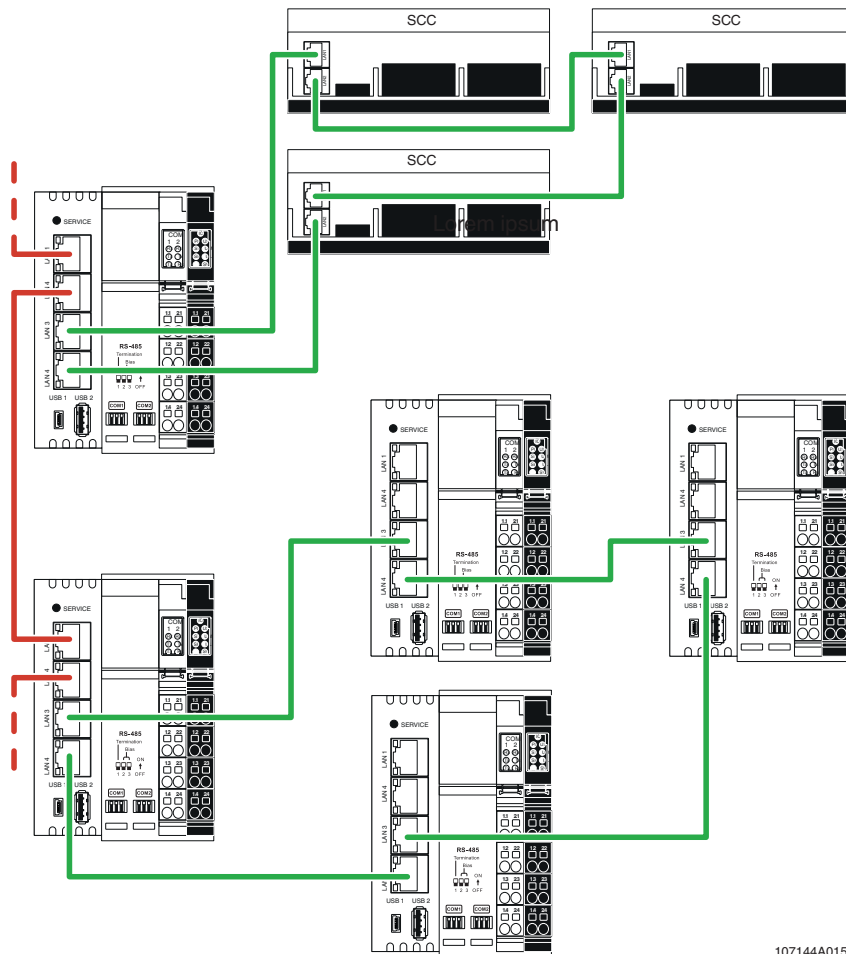
LAN 1	eth1
LAN 2	
LAN 3	eth0
LAN 4	

Table 3-6 LAN 4 at eth0, LAN1 ... 3 at eth1

LAN 1	eth1
LAN 2	
LAN 3	
LAN 4	eth0

If several Ethernet interfaces are assigned to one IP interface, that IP interface can be reached via every Ethernet interface. Direct communication is possible between the Ethernet interfaces, so several devices can be interconnected in a line topology, see [Figure 3-12](#).

Ethernet communication is not possible between Ethernet interfaces belonging to different IP interfaces.



107144A015

Figure 3-12 Example of Ethernet cabling

### 3.4.2 Ethernet ring monitoring

Ethernet interfaces LAN 3 and LAN 4 can be used to create an Ethernet ring, provided that both interfaces are assigned to eth0. The Ethernet ring connects Ethernet field devices with integrated unmanaged switches, which feature at least two Ethernet interfaces. The Ethernet ring guarantees Ethernet communication even if a connection within the ring is interrupted, see [Figure 3-12](#).

If the ring is completely closed and the Ethernet switches within it are configured as unmanaged, there is the risk of a broadcast storm. This risk comes from broadcast and multicast messages being forwarded constantly, and thus circulating in the ring all the time, which generates a high communication load. The Ethernet ring monitoring function continuously checks the status of the ring and ensures that LAN 4 is deactivated whenever the ring is intact. If the ring is interrupted, LAN 4 is activated.



The aging time of the Ethernet switches present in the ring will determine the time it takes to fully restore communication within the ring.



### 3.4.3 Rapid Spanning Tree Protocol (RSTP)

The Rapid Spanning Tree Protocol (RSTP) enables any redundant, fault-tolerant Ethernet structure to be created, not just a ring structure. Redundant paths in the system are identified and deactivated, provided they are not required. As soon as a connection which has a redundant path is interrupted, that path is closed to replace the interrupted connection. With RSTP, it takes just a few seconds to restore interrupted communication.



All Ethernet switches involved in the RSTP structure must support RSTP and be appropriately configured for it.

See [Table 3-7](#) to [Table 3-10](#) for the possible configurations as regards RSTP. An LAN port can be configured for RSTP once at least one other LAN port has been assigned to the same IP interface. Each column represents a possible RSTP configuration. Cells containing an "X" indicate LAN ports as RSTP devices.

Table 3-7 LAN 1 ... 4 at eth0, eth1 is deactivated

eth	LAN	RSTP configuration						
0	1				X	X	X	X <sup>1</sup>
	2			X	X	X	X	X <sup>1</sup>
	3		X	X	X		X	X <sup>2</sup>
	4		X	X	X			X <sup>2</sup>

<sup>1</sup> RSTP topologies that are independent of one another

<sup>2</sup> RSTP topologies that are independent of one another

Table 3-8 LAN 2 ... 4 at eth0, LAN 1 at eth1

eth	LAN	RSTP configuration		
1	1			
0	2			X
	3		X	X
	4		X	X

Table 3-9 LAN 3 ... 4 at eth0, LAN 1 ... 2 at eth1 (delivery state)

eth	LAN	RSTP configuration			
1	1			X	X
	2			X	X
0	3		X		X
	4		X		X

Table 3-10 LAN 4 at eth0, LAN1 ... 3 at eth1

eth	LAN	RSTP configuration		
1	1		X	X
	2		X	X
	3			X
0	4			

### 3.4.4 Interface status information

If ring monitoring or RSTP is activated, the status of the external Ethernet interfaces is shown in the Niagara application, in the Sedona application, and on the startup website for analysis purposes. This enables redundancy to be monitored in network topologies.

Niagara Station Config, Drivers, SysmikScaloNetwork, LocalPlatform, EthSwitch  
Lan1State ... Lan4State: Status Boolean

- True {ok} = FORWARDING
- False {ok} = BLOCKING
- xxx {stale}: no up-to-date information available (no RSTP or loop active)
- xxx {disabled}: status recording inactive (can be managed via "Config, Drivers, Sysmik-ScaloNetwork, LocalPlatform, EthSwitch.Enabled")

### 3.4.5 Broadcast storm avoidance

The broadcast storm avoidance function, which can be adjusted via the startup website, limits data throughput for multicast and broadcast packets to a configurable value of 0.032/0.05/0.1/0.5/1/2/5/10/20 Mbps (default setting: 1 Mbps). The setting applies to all four interfaces.

Redundant paths cannot be excluded with ring monitoring and RSTP. From the moment a topology changes, it takes a few seconds until the reorganization is performed, during which time a broadcast storm can occur. A broadcast storm can suppress management messages for ring monitoring and RSTP, and disrupt the reorganization process. The broadcast storm avoidance function limits the load generated by broadcast and multicast messages, thus stopping any broadcast storms.

## 3.5 Integration with the Niagara Framework®

### Communication protocols

The Niagara Framework® contains many communication protocols, which are also automatically available in the Inline controller:

- BACnet IP
- BACnet MS/TP (only on COM1 and COM2)
- LonWorks IP852
- LonMark TP/FT-10 (ILC 2050 BI-L only)
- Modbus/TCP
- Modbus/RTU, M-Bus
- KNX/IP
- SNMP
- oBIX
- ...

You can integrate and link data points from different sources via the communication protocols. In addition Niagara contains comprehensive processing and system functions such as trend log, alarming, time switch, web visualization, report generators, interfaces to email, SMS, databases, etc. Engineering is carried out with the Niagara Workbench.

### 3.5.1 Local I/O access

The components of the “SysMikScalo” kit allow you to access the Inline terminals. Here, the Niagara Driver Framework® “Network – Device – Point” approach is applied consistently: “SysMikScaNetwork – terminals – data points (I/O channels)”.

In the “Driver Manager”, standard view of “Station, Config, Drivers”, a “SysmikScaloNetwork” is created via “New”.

### “N Device Manager”

In “N Device Manager”, the standard view of the “SysmikScaloNetwork”, you can read in the connected Inline terminals via “Discover”. Use “Add” to add the discovered Inline terminals into the application.

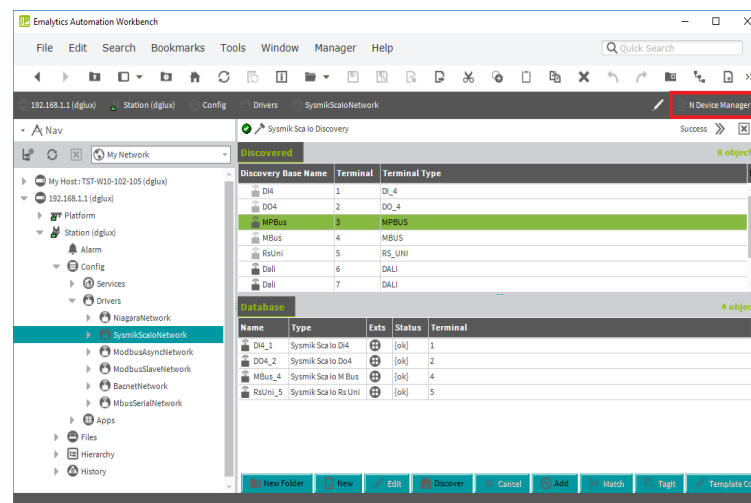


Figure 3-13 “N Device Manager” in the “SysMikScaloNetwork”

**“N Point Manager”**

In “N Point Manager”, the standard view of the point folder of the terminal components, you can display the I/O channels available via “Discover”. You can add the available I/O channels into the application as proxy points using “Add”. Some data points have special functions:

- You can parameterize the measuring ranges of the analog input terminals via the additional Properties (Ai type) of the proxy extension.
- You can initialize count values of the counter terminal via the “Init Counter” action of the proxy extension.

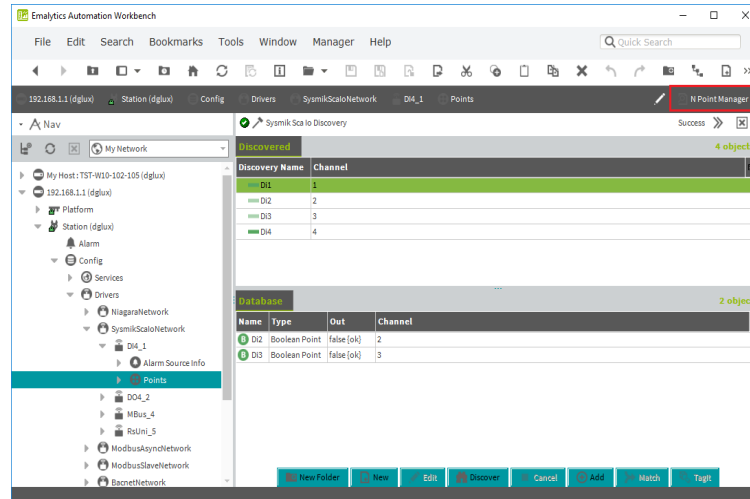


Figure 3-14 “N Point Manager” of a terminal component

### 3.5.2 Serial interfaces

The Inline controller has two serial RS-485 interfaces, which are also available for any serial protocols via the interface names COM1 and COM2 (see also [Section “Serial interfaces” on page 15](#)).

You can add further universal serial interfaces to the Inline controller by attaching Inline terminals of type IB IL RS UNI-PAC (Order No. 2700893). These Inline terminals support the RS-232, RS-485, and RS-422 interface standards, which can be parameterized via corresponding terminal components in the SysMikScaNetwork with the Niagara Workbench. These serial interfaces, added via Inline terminals, can be used for all serial protocols except BACnet MS/TP.

Inline terminals of type IB IL MBUS-PAC (Order No. 2701927) extend the Inline controller with serial interfaces corresponding to the M-Bus standard for the connection of up to 30 M-Bus slaves and control by means of the Niagara M-Bus driver.

The interface names of the Inline terminals are issued according to their installation order, beginning with COM3. A summary of all serial interfaces, including their current use (“Owner”) is available under “Station, Config, Services, PlatformServices, SerialPortPlatformServiceNpsdk”.

Example

Figure 3-15 shows this overview for an Inline controller with a total of four serial interfaces – the two serial interfaces of the Inline controller and two further serial interfaces, which were added via Inline terminals:

- COM1: the first RS-485 interface on the Inline controller is occupied by the MS/TP port of the BACnetNetwork.
- COM2: the second RS-485 interface on the Inline controller is assigned to the Modbus-SlaveNetwork.
- COM3: the IB IL MBUS-PAC Inline terminal in terminal position 5 is used as an interface of the MbusNetwork.
- COM4: the IB IL RS UNI-PAC Inline terminal in terminal position 4 serves as an interface for the ModbusAsyncNetwork; to this end, interface standard RS-485 is selected in the terminal component's Property Sheet, in the SysmikScaloNetwork, under property Rs Type (see Figure 3-16).

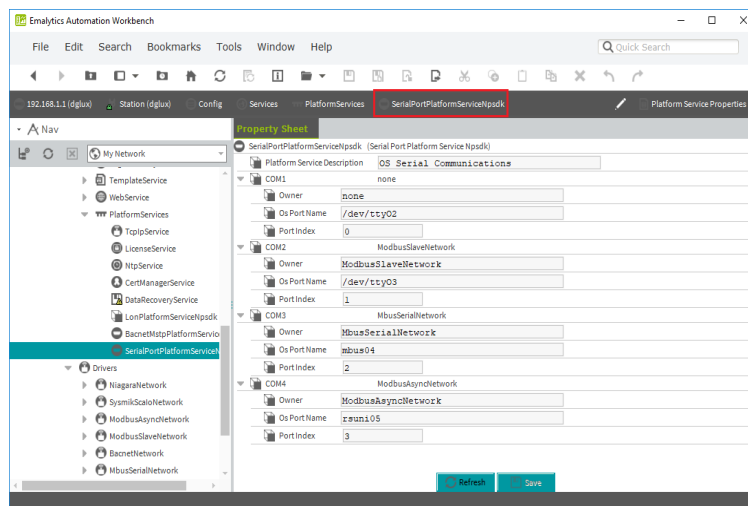


Figure 3-15 SerialPortPlatformServiceNpsdk

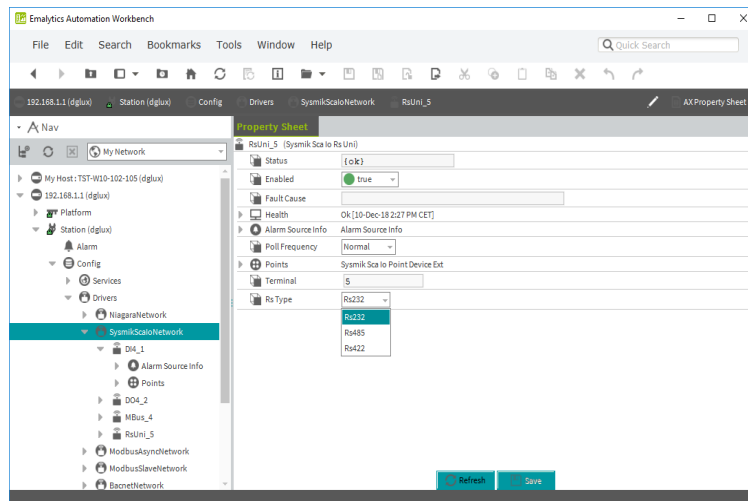


Figure 3-16 IB IL RS UNI-PAC interface parameterization

### 3.5.3 Remote control of the Inline terminals

To access the Inline terminals, the SysMikScaloNetwork establishes a TCP connection to an I/O server. You can specify the IP address and port of the I/O server via the “Address” property. The default IP address is the local IP address 127.0.0.1:2015, through which the local I/O server is contacted. It is also possible to establish the connection to an I/O server on another device by parameterizing the corresponding IP address.

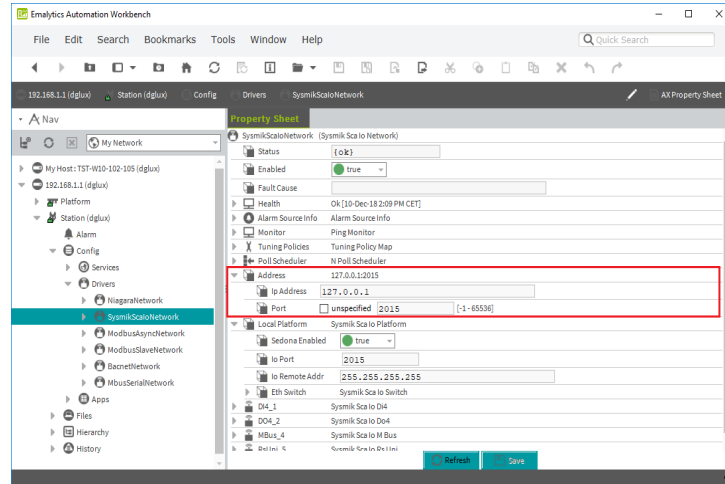


Figure 3-17 Parameterization of the IP address of the I/O server to be contacted

To prevent unwanted remote control by unknown controllers, you can parameterize a remote control address for the Inline controller in the Niagara Workbench, via “Station, Config, Drivers, SysMikScaloNetwork, localPlatform, IoRemoteAddr”. In the delivery state, 255.255.255.255 is entered here – with this setting, remote control is possible from any IP address. If you enter a special IP address, remote control can only take place from this IP address. Enter an invalid IP address (empty string) to deactivate remote control. Furthermore, via “Station, Config, Drivers, SysMikScaloNetwork, localPlatform, IoPort”, you can specify the TCP port number of the I/O server.

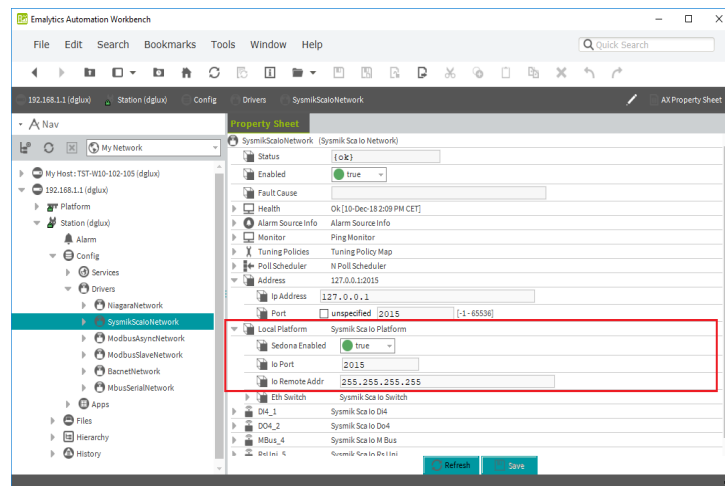


Figure 3-18 Parameterization of the I/O server

### 3.6 Concurrent access to the Inline terminals

As already explained, multiple software components of the Inline controller can control the Inline terminals of the Inline system. For reading input data, this does not pose a problem. For output data and parameterizations, however, the software components can work against each other. To ensure that the behavior of the Inline terminals is traceable, the following priority control, which works on a channel by channel basis, was implemented.

Each source can specify a value with source-specific priority or release the source-specific priority. This release is achieved by means of technology-specific values:

Table 3-11 Release values of priority control

Type	Startup website	Sedona	Niagara
Digital output, Boolean	Auto	Zero	Zero
Analog output, DALI controller, float	Auto	Nan (not a number)	Zero
Enum measuring range	Auto	Auto	Auto

If multiple sources define values for the same I/O channel, the following hierarchy applies:

Table 3-12 Hierarchy of priority control

Rank	Niagara
1	Startup website
2	Sedona
3	Niagara local
4	Niagara remote (remote control)

The startup website has highest priority. Irrespective of the other program parts, a manual override can be initiated here at any point. When logging out of the startup website, all overrides are automatically canceled again.

In the case of Sedona and Niagara, the components are always initialized in such a way that they release their priority. Priority is only assigned with explicit parameterization or linking to other components.



Priorities are not automatically released when deleting or readdressing components. You can ensure release prior to deletion by explicitly specifying the release value. By restarting the Inline controller, the entire internal priorities array is also reinitialized (released).

Depending on the data point type, the following default values, which are automatically valid if all priorities are released (i.e., if no software component defines anything), are defined:



Table 3-13 Default values of priority control

Data point type	Default value
Output signal of a digital output	Off
Output signal of an analog output	0.0 V
DALI controller ballast	0.0%
Measuring range of an analog input	0 V ... 10 V, if available

Some actions have the character of commands. They are not interlocked via the priority control, rather they are executed in the sequence in which they arise. These include:

- Initialization of count values of the counter terminal
- DALI light control commands
- Initialization, reading, and writing functions for the Inline terminals



Program your application so it **cannot** be accessed inadvertently through several sources.

## 4 Technical data and ordering data

### 4.1 Technical data

General data	
Dimensions	80 mm x 119.8 mm x 71.5 mm
Weight	Approx. 230 g
Connection data for connectors	
Connection method	Spring-cage connection
Conductor cross section	
Single-wire/terminal point, rigid	0.08 mm <sup>2</sup> to 1.5 mm <sup>2</sup>
Single-wire/terminal point, flexible	0.08 mm <sup>2</sup> to 1.5 mm <sup>2</sup>
Single-wire/terminal point, AWG	28 to 16
	Phoenix Contact recommends using conductors with a conductor cross section of 0.2 mm <sup>2</sup> to 1.5 mm <sup>2</sup> .
Processor core	
Processor / clock	ARM <sup>®</sup> Cortex <sup>®</sup> -A8 32-bit RISC processor / 1 GHz
DDR3 SDRAM	1 GB (512 MiB for hardware version <06, see series label)
eMMC	1.8 GB
SRAM	512 KiB buffered for 5 days
RTC	Power reserve for 5 days

**Network interface**

Ethernet connection	4 x 10/100 BASE-T
MDI/MDI-X crossover	Automatic
Aging time	330 s, typical
Electrical isolation LAN 1/2/3/4 to module	Test voltage 1500 V AC, 1 min <sup>1</sup>
Electrical isolation LAN 1 to LAN 2 to LAN 3 to LAN 4	Test voltage 1500 V AC, 1 min <sup>1</sup>
RS-485 connection	
Maximum number of bus devices	256 (1/8 unit load)
Maximum data rate	200 kbps
Electrical isolation RS-485 to module (see Figure 2-4)	Test voltage 500 V AC, 50 Hz, 1 min <sup>1</sup>
Electrical isolation RS-485 COM1 to COM2	Test voltage 500 V AC, 50 Hz, 1 min <sup>1</sup>
TP/FT-10	2-wire twisted-pair bus connection for free topologies
Transceiver	TP/FT-10
Electrical isolation LON vs. module (see Figure 2-4)	Test voltage 250 V AC, 50 Hz, 1 min <sup>2</sup>

- <sup>1</sup> Separation of functions! The isolation is bridged for interference elimination with an RC filter and does not fulfil the safety regulations for protection against dangerous shock voltages.
- <sup>2</sup> Separation of functions! The isolation is bridged for interference elimination with a 300 V varistor and does not fulfil the safety regulations for protection against dangerous shock voltages.

**Connection of Inline terminals**

Maximum number of Inline terminals in an Inline station	63
Maximum current of the bus controller in the logic range (UL)	2 A
Maximum current carrying capacity of the potential jumpers (U <sub>ANA</sub> )	0.5 A
Maximum current carrying capacity of the potential jumpers U <sub>M</sub> , U <sub>S</sub> , and GND (total current)	8 A

**Controller supply**

Operating voltage U <sub>BK</sub>	24 V DC
Maximum permissible voltage range	19.2 V DC ... 30 V DC
Current consumption at nominal voltage without local bus devices	
I <sub>BK</sub>	≤ 170 mA
Current consumption at nominal voltage with local bus devices without U <sub>M</sub> and U <sub>S</sub>	≤ 1.5 A (7.5 V logic supply loaded with 2 A)
I <sub>BK</sub> <sup>1</sup>	24 V analog voltage loaded with 0.5 A without USB devices

- <sup>1</sup> Separation of functions! The isolation is bridged for interference elimination with a 300 V varistor and does not fulfil the safety regulations for protection against dangerous shock voltages.

**Ambient conditions**

Degree of protection	IP20 (EN 60529:1991)
Ambient temperature (operation)	-25°C ... +55°C
Permissible temperature (storage/transport)	-25°C ... +85°C
Temperature class	T4



This temperature range is only guaranteed if the Inline controller is mounted horizontally.

Permissible humidity (operation/storage/transport)	0% ... 75%, in accordance with DIN EN 61131-2 (non-condensing, no ice formation)
Permissible air pressure (operation/storage/transport)	70 kPa ... 106 kPa (up to 3000 m above sea level)
<b>Gases that may endanger functions in accordance with DIN 40046-36, DIN 40046-37</b>	
Sulfur dioxide (SO <sub>2</sub> )	Concentration 10 ±0.3 ppm Ambient conditions - Temperature: 25°C (±2°C) - Humidity: 75% (±5%) - Test duration: 10 days
Hydrogen sulfide (H <sub>2</sub> S)	Concentration 1 ±0.3 ppm Ambient conditions - Temperature: 25°C (±2°C) - Humidity: 75% (±5%) - Test duration: 4 days
Resistance of housing material to termites	Resistant
Resistance of housing material to fungal decay	Resistant

**Conformance with EMC Directive 2014/30/EC**

**Noise immunity test in accordance with EN 61000-6-2**

Electrostatic discharge (ESD)	EN 61000-4-2/ IEC 61000-4-2	Criterion B 6 kV contact discharge 8 kV air discharge
Electromagnetic fields	EN 61000-4-3 IEC 61000-4-3	Criterion A Field strength: 10 V/m
Fast transients (burst)	EN 61000-4-4/ IEC 61000-4-4	Criterion B Supply lines: 2 kV Signal/data cables: 1 kV
Surge test	EN 61000-4-5 IEC 61000-4-5	Criterion B Signal/data lines: 1 kV Supply lines line-to-line: 0.5 kV Supply lines line-to-earth: 1.0 kV
Conducted disturbance variables	EN 61000-4-6 IEC 61000-4-6	Criterion A Test voltage 10 V

**Noise emission test in accordance with EN 61000-6-3 (residential and commercial spaces)**

Noise emissions	EN 55022	Class B
-----------------	----------	---------

## 4.2 Ordering data ILC 2050 BI(-L)

Description	Type	Order No.	Pcs./Pkt.
The modular Inline controller for automation applications in infrastructure, energy, and buildings is based on the Niagara 4 Framework <sup>®</sup> . Four LAN, two USB, and two RS-485 interfaces are integrated. The controller can be extended with numerous Inline I/O modules.	ILC 2050 BI	2403160	1
The modular Inline controller for automation applications in infrastructure, energy, and buildings is based on the Niagara 4 Framework <sup>®</sup> . Four LAN, two USB, and two RS-485 interfaces, and one LON interface (CEA-709) are integrated. The controller can be extended with numerous Inline I/O modules.	ILC 2050 BI-L	2404671	1

# A Technical appendix

## A 1 Fault avoidance

### A 1.1 Performance and resource management

All software processes share the available resources (processor time, memory).

The complexity of the applications has a large impact on how resources are utilized, but so too do the interface definitions, particularly the connected I/O terminals. On the one hand, every data point consumes resources simply by existing. On the other hand, each data point is normally processed within the application, thus increasing the application's size.



None of the quantitative data given below is warranted; it serves only as a guide for estimating the load due to connected Inline terminals. Always take the conditions of your specific application into account.

#### Inline terminals

Up to 63 Inline terminals can be connected to one controller (input/output terminals, function terminals). This is a theoretical maximum number, which is already restricted by the mechanical overall width of the complete station. The more Inline terminals connected, the longer it takes to exchange data between the controller and Inline terminals. Digital input and output terminals have the least significant impact.

If 63 digital input/output terminals are connected, each with 32 channels, the station would have 2016 data points and an overall width of over 3 m. Boost and segment terminals would make the Inline station even wider.

#### IB IL DALI/PWR-PAC, IB IL DALI-PAC, IB IL DALI/MM-PAC

A DALI terminal can address up to 81 data points (64 individual addresses, 16 group addresses, one broadcast). The amount of resources required will vary, depending on the number of DALI devices and type of control (required resources listed here in ascending order):

- Broadcast addressing (one data point, no status), using scenes where applicable
- Group addressing (few data points, which can only be written when being modified, no status)
- Random addressing (many data points, which can only be written when being modified)
- Random addressing with evaluation of lamp status (many data points, which are polled cyclically)
- Random or group addressing with additional use of DALI sensors

Although, for example, broadcast addressing does not need many resources and so would allow for the maximum of 63 DALI terminals, if the DALI buses are being utilized at a higher level, no more than eight DALI terminals should be connected to an Inline controller. When using DALI sensors in particular, the desired response time is a crucial factor.

### IB IL RS UNI-PAC, IB IL MBUS-PAC

These Inline terminals act as an interface to a serial bus, to which up to 30 devices (M-Bus) or even more can be connected. The limiting factor here is the required polling or response speed.

In theory, a maximum of 16 serial Inline terminals could be connected. However, no more Inline terminals (e.g., input/output terminals) could then be connected after that. We therefore recommend connecting a maximum of eight serial Inline terminals.

With Modbus/RTU, the maximum number of approximately four to five messages per second can be achieved if one Inline terminal of type IB IL RS UNI-PAC is connected. If eight Inline terminals of type IB IL RS UNI-PAC are connected, the number of messages drops to approximately two per second for each connected Inline terminal.

#### Showing the available resources

You can use the Niagara Workbench to show the available resources via all the access points:

Platform: "Platform Administration"

Station: "Views, Resource Manager"

Sedona: "App, service, plat"

The system capacity should not be at 100%, as in this case the time specifications (cycle times) can no longer be fulfilled.

- In this event, optimize your application, e.g., by increasing the Sedona task runtimes or intervals (e.g., poll intervals) of the Niagara application.
- Bear in mind that every type of communication during operation generates a processor load. Leave a reserve for this.

## A 1.2 Reliability of the nonvolatile flash memory

The Inline controller contains an integrated flash memory for use in an industrial temperature range. The reliability of the flash memory is physically restricted by the frequency of writing operations and the ambient temperature. If large amounts of data are written frequently, this will cause the flash memory to age faster, while a high ambient temperature will reduce the guaranteed data retention time.

Due to the system, the memory load caused by write access is strongly dependent on the application. Write access required when programming or performing software updates can result in large amounts of data being written to the flash memory. However, these amounts are negligible compared to the data volumes generated during regular program-related sequences (such as when saving history data and carrying out a "StationSave").

The write load created by history data can be ascertained under "Station, Config, Services, PlatformServices, DataRecoveryService". The size and write frequency of history data should be selected such that a data recovery block is not saved more than once per minute.

"StationSave" should take place much less than once an hour.

With regard to the ambient temperature, the maximum values specified in [Section "Technical data" on page 58](#), taking the mounting position into account (see [Section "Mounting and removing the Inline controller" on page 21](#)), should never be exceeded.

## A 2 Diagnostics

The most frequent faults arise in conjunction with other devices or components. Therefore, when a fault occurs the Inline controller should not be isolated straightaway; instead, it should be viewed as part of the system as a whole.

Various tools are available for fault localization; these are explained in [Section “Diagnostic and status indicators” on page 10](#):

- Supply LEDs
- Process status LEDs
- I/O status LED
- Communication LEDs
- Service LED
- Ethernet status LEDs

Niagara also features wide-ranging diagnostic tools for analyzing communication in connected automation networks.

Before carrying out a detailed analysis of any fault, make sure that the device is properly wired, is being supplied with power, and has booted up. Pay particular attention to the following:

- All spring terminals and snap-in latches are properly engaged.
- The DIN rail is correctly grounded.
- The functional ground connection of the Inline controller is connected to the DIN rail via a 1.5 mm<sup>2</sup> conductor with a grounding terminal.
- The UM, US, and UL LEDs are permanently lit.
- The supply voltage is within the specified tolerances (see also [Section 2.10](#) and [Section 4.1](#)).

The process status LEDs provide a reliable indication of the operating state (see [Section “Diagnostic and status indicators” on page 10](#)). The boot process is only complete when these flash steadily with a brief light-up duration.



### A 3 Fault causes and remedies

Table A-1 Fault causes and remedies

Fault	Cause	Remedy
System shell or startup website cannot be reached.	A USB cable is required between the USB interface on the PC and the mini USB port on the Inline controller in order to run these two programs.	<ul style="list-style-type: none"> <li>• Check that the USB cable is undamaged and inserted correctly in the USB interfaces.</li> <li>• Check whether the device “NDIS-compatible remote device” is displayed under Network Adapter in the PC device manager. If not, install the device driver (see <a href="#">Section “Mini USB interface” on page 16</a>).</li> </ul>
The IP address is unknown.	–	<p>The Inline controller IP addresses can be displayed and modified via the system shell or the startup website. Both access points operate independently of the IP addresses via a local USB connection to the Inline controller.</p> <ul style="list-style-type: none"> <li>• Check the IP settings and adapt them to your application, if necessary (see <a href="#">Section “Assigning the IP address” on page 43</a>).</li> </ul>
IP communication is not working.	–	<ul style="list-style-type: none"> <li>• Use the Ethernet status LEDs to check that the Inline controller is connected correctly.</li> <li>• Check the Ethernet connection between two devices via a ping command. The system shell (see <a href="#">Section “System shell” on page 33</a>) has a ping function.</li> <li>• Check the IP addresses and subnet masks of the devices that are supposed to be communicating with one another. In particular, ensure that each IP address is only assigned once and appropriate subnets are assigned.</li> </ul>
Access data for the Niagara platform is unknown.	–	<p>If you do not have the access data for the Niagara platform, proceed as follows:</p> <ul style="list-style-type: none"> <li>• Press the service button (see <a href="#">Section “Connection and operating elements” on page 8</a>) to reset the access data to the default settings (user: “sysmik”, password: “intesa”).</li> <li>• Restart the Inline controller and press the service button at exactly the right time (see <a href="#">Table 2-1 on page 10</a>).</li> </ul>

Table A-1 Fault causes and remedies

Fault	Cause	Remedy
<p>No platform connection to the device – platform daemon does not start</p>	<p>Duplicate usage of the daemon HTTP port:</p> <p>The daemon HTTP port must not be used by other system components (e.g., by the I/O server port).</p>	<ul style="list-style-type: none"> <li>Use the system shell (see <a href="#">Section “System shell” on page 33</a>) or the startup website (see <a href="#">Section “Startup website” on page 35</a>) to check whether other software components (webserver, I/O server) are using the daemon HTTP port (default: Standard 3011/Secure 5011).</li> </ul> <p>You can reset the daemon HTTP port to default settings using the service button (see <a href="#">Section “Connection and operating elements” on page 8</a>) or the system shell.</p>
	<p>Date of the real-time clock (RTC) in an invalid range:</p> <p>If the Inline controller is not supplied with power for several days, e.g., during storage, the real-time clock may lose the set date. When restarted, the real-time clock sets the date to a random value.</p> <p>A date outside the range 2015-06-11 to 2020-12-29 will prevent the Niagara platform daemon from starting.</p>	<ul style="list-style-type: none"> <li>Use the system shell to set the date to a value within the specified range.</li> <li>Use the system shell or the startup website to check the version of the operating system (device software).</li> <li>If the version ≤ 1.0.1.2: update the device software.</li> </ul> <p>With version 1.0.1.3 and higher, a date outside the specified range will be corrected automatically.</p>
<p>Sedona Virtual Machine (SVM) does not start.</p>	<p>If Sedona files (app.sab and kits.scode) in the Inline controller are defective or inconsistent, the SVM cannot start. In this case, no device connection can be established between the Niagara<sup>AX</sup> Workbench and the Inline controller. This means that the Sedona tools for correcting this status are not available either.</p>	<ul style="list-style-type: none"> <li>Press the service button (see <a href="#">Section “Connection and operating elements” on page 8</a>) to reset the access data to the default settings (user: “sysmik”, password: “intesa”).</li> <li>Restart the Inline controller and press the service button at exactly the right time (see <a href="#">Table 2-1 on page 10</a>).</li> </ul>

## A 4 Derating

As the logic and USB supply is provided from the internal power supply unit of the Inline controller, when the load on the logic and USB supply increases, so does power dissipation in the Inline controller. You must observe derating, according to the mounting position (see [Figure A-1](#)). The preferred mounting position (for the lowest derating level) is horizontal (DIN rail horizontal on the control cabinet panel).

The power dissipation of the Inline controller's power supply unit due to the USB load  $P_{\text{USB}}$  and the connected terminals  $P_{\text{PERI}}$  is determined as described in [Section "Calculating the power dissipation" on page 28](#).

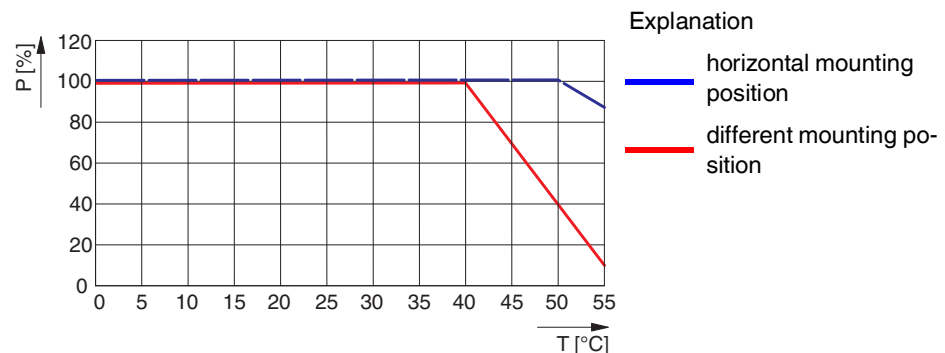


Figure A-1 Derating characteristic curves of the Inline controller's power supply unit power dissipation

For the logic supply load applied by the individual Inline terminals, refer to the respective data sheets.

At the maximum permissible logic current of 2 A and USB current of 2 x 500 mA, a nominal power dissipation of the bus controller power supply unit of 100% is calculated at temperatures up to 40°C:

$$P_V = 1.0 \text{ V} \times I_L + 0.7 \text{ V} \times I_{\text{USB}}$$

$$P_V = 1.0 \text{ V} \times 2.0 \text{ A} + 0.7 \text{ V} \times 1.0 \text{ A} = 2.7 \text{ W}$$

For higher ambient temperatures, the currents  $I_L$  and  $I_{\text{USB}}$  must be reduced as per [Figure A-1](#).

### Example 1: Horizontal mounting position

Given an ambient temperature of 55°C and a horizontal mounting position, the power supply unit power dissipation is limited to just 87% of the rated power dissipation, as per [Figure A-1](#). The power dissipation must therefore be reduced to 2.35 W. Suppose that  $I_L$  is loaded with the maximum permitted 2 A. Then the current load on the USB slots may amount to a maximum of 0.5 A:

$$I_{\text{USB}} = (0.87 \times P_V - 1 \text{ V} \times I_L) / 0.7 \text{ V}$$

$$I_{\text{USB}} = (2.35 \text{ W} - 2 \text{ W}) / 0.7 \text{ V}$$

$$I_{\text{USB}} = 0.5 \text{ A}$$

**Example 2:  
Different mounting position**

Given an ambient temperature of 45°C and a non-horizontal mounting position, a USB device also needs to be supplied with 200 mA. The power supply unit dissipation may amount to 70% in this case, i.e., 1.89 W. For the maximum current from  $U_L$ , this results in:

$$I_L = (0.7 \times P_V - 0.7 \text{ V} \times I_{\text{USB}}) / 1 \text{ V}$$

$$I_L = (1.89 \text{ W} - 0.14 \text{ W}) / 1 \text{ V}$$

$$I_L = 1.75 \text{ A}$$

# B Appendix for document lists

## B 1 List of figures

### Section 2

Figure 2-1:	Structure of the Inline controller .....	8
Figure 2-2:	Assignment of DIP switches for RS-485 termination .....	9
Figure 2-3:	Diagnostic and status indicators .....	10
Figure 2-4:	Internal basic circuit diagram .....	13
Figure 2-5:	Connection assignment of Ethernet interfaces .....	14
Figure 2-6:	Connections of the bus connector .....	15
Figure 2-7:	Selecting a network adapter .....	17
Figure 2-8:	Structure of the Inline controller software .....	19
Figure 2-9:	Inline controller dimensions .....	20
Figure 2-10:	Mounting the Inline controller (1) .....	22
Figure 2-11:	Mounting the Inline controller (2) .....	22
Figure 2-12:	Connectors to be removed when Inline terminals are at- tached .....	23
Figure 2-13:	Removing the Inline controller (1) .....	24
Figure 2-14:	Removing the Inline controller (2) .....	24
Figure 2-15:	Supply UM/UBK and US from different voltage sources (A) and from one common voltage source (B) .....	26
Figure 2-16:	Schematic view of functional ground of the Inline controller .....	27

### Section 3

Figure 3-1:	Telnet client (example): establishing a connection to the Tel- net server .....	33
Figure 3-2:	System shell (example) .....	34
Figure 3-3:	Startup website: Overview .....	35
Figure 3-4:	Startup website: "Settings, Network" .....	36
Figure 3-5:	Startup website: "Settings, Date/Time" .....	37
Figure 3-6:	Startup website: "Settings, IO Server" .....	38
Figure 3-7:	Startup website: "Settings, Run" .....	39
Figure 3-8:	Startup website: "Settings, Switch" .....	40
Figure 3-9:	Startup website: „Settings, WLAN“ .....	41
Figure 3-10:	Startup website: "Terminals" .....	42
Figure 3-11:	Data point test via the startup website .....	45

Figure 3-12:	Example of Ethernet cabling .....	48
Figure 3-13:	“N Device Manager” in the “SysMikScaloNetwork” .....	51
Figure 3-14:	“N Point Manager” of a terminal component .....	52
Figure 3-15:	SerialPortPlatformServiceNpsdk .....	54
Figure 3-16:	IB IL RS UNI-PAC interface parameterization .....	54
Figure 3-17:	Parameterization of the IP address of the I/O server to be contacted .....	55
Figure 3-18:	Parameterization of the I/O server .....	55

## Appendix A

Figure A-1:	Derating characteristic curves of the Inline controller’s power supply unit power dissipation .....	67
-------------	---	----

## B 2 List of tables

### Section 2

Table 2-1:	Diagnostic and status indicators .....	10
Table 2-2:	Connection assignment of the bus connector .....	15
Table 2-3:	Connection assignment of the feed-in terminal .....	27

### Section 3

Table 3-1:	Software settings in the Inline controller delivery state .....	31
Table 3-2:	Protocols via USB OTG .....	32
Table 3-3:	LAN 1 ... 4 at eth0, eth1 is deactivated .....	46
Table 3-4:	LAN 2 ... 4 at eth0, LAN 1 at eth1 .....	46
Table 3-5:	LAN 3 ... 4 at eth0, LAN 1 ... 2 at eth1 (delivery state) .....	47
Table 3-6:	LAN 4 at eth0, LAN1 ... 3 at eth1 .....	47
Table 3-7:	LAN 1 ... 4 at eth0, eth1 is deactivated .....	49
Table 3-8:	LAN 2 ... 4 at eth0, LAN 1 at eth1 .....	49
Table 3-9:	LAN 3 ... 4 at eth0, LAN 1 ... 2 at eth1 (delivery state) .....	49
Table 3-10:	LAN 4 at eth0, LAN1 ... 3 at eth1 .....	49
Table 3-11:	Release values of priority control .....	56
Table 3-12:	Hierarchy of priority control .....	56
Table 3-13:	Default values of priority control .....	57

### Appendix A

Table A-1:	Fault causes and remedies .....	65
------------	---------------------------------	----





## B 3 Index

### B

Basic circuit diagram ..... 13

### C

Concurrent access ..... 56

Connection elements ..... 8

Current consumption..... 29

### D

Data point test..... 45

Diagnostic indicators..... 10

Dimensions ..... 20

DIN rail ..... 21

Drivers..... 16

### E

End bracket..... 21

End plate..... 21

Ethernet ..... 14

### F

Flash memory ..... 63

FTP ..... 43

### I

I/O server ..... 19

Interface..... 14

IP address..... 43

### L

Local access ..... 16, 32

Local bus interface..... 17

LON ..... 16

LonMark..... 16

### M

Mounting..... 22

Mounting location..... 21

Mounting position..... 21

### O

Operating elements..... 8

Ordering data..... 61

### P

Performance management ..... 62

Power dissipation..... 28

Power supply ..... 25

Processor core..... 7

### R

Remote control ..... 55

Removal..... 23

Resource management..... 62

Reverse polarity ..... 30

RS-232..... 53

RS-422..... 53

RS-485..... 15

### S

Safety equipment..... 30

Sedona Virtual Machine ..... 20

Serial interfaces ..... 15, 53

Startup ..... 43

Startup website ..... 20, 35

Status indicators ..... 10

Surge voltage..... 30

System shell..... 19, 33

### T

Technical data ..... 58

Time..... 44

### U

Unauthorized access ..... 32

#### USB

Mini USB ..... 16

USB OTG ..... 16, 32

USB type A..... 17

### W

#### WLAN

Settings ..... 41



---

## Please observe the following notes

### **General terms and conditions of use for technical documentation**

Phoenix Contact reserves the right to alter, correct, and/or improve the technical documentation and the products described in the technical documentation at its own discretion and without giving prior notice, insofar as this is reasonable for the user. The same applies to any technical changes that serve the purpose of technical progress.

The receipt of technical documentation (in particular user documentation) does not constitute any further duty on the part of Phoenix Contact to furnish information on modifications to products and/or technical documentation. You are responsible to verify the suitability and intended use of the products in your specific application, in particular with regard to observing the applicable standards and regulations. All information made available in the technical data is supplied without any accompanying guarantee, whether expressly mentioned, implied or tacitly assumed.

In general, the provisions of the current standard Terms and Conditions of Phoenix Contact apply exclusively, in particular as concerns any warranty liability.

This manual, including all illustrations contained herein, is copyright protected. Any changes to the contents or the publication of extracts of this document is prohibited.

Phoenix Contact reserves the right to register its own intellectual property rights for the product identifications of Phoenix Contact products that are used here. Registration of such intellectual property rights by third parties is prohibited.

Other product identifications may be afforded legal protection, even where they may not be indicated as such.

---

## How to contact us

### Internet

Up-to-date information on Phoenix Contact products and our Terms and Conditions can be found on the Internet at:

[phoenixcontact.com](http://phoenixcontact.com)

Make sure you always use the latest documentation.

It can be downloaded at:

[phoenixcontact.net/products](http://phoenixcontact.net/products)

### Subsidiaries

If there are any problems that cannot be solved using the documentation, please contact your Phoenix Contact subsidiary.

Subsidiary contact information is available at [phoenixcontact.com](http://phoenixcontact.com).

### Published by

PHOENIX CONTACT GmbH & Co. KG

Flachsmarktstraße 8

32825 Blomberg

GERMANY

PHOENIX CONTACT Development and Manufacturing, Inc.

586 Fulling Mill Road

Middletown, PA 17057

USA

Should you have any suggestions or recommendations for improvement of the contents and layout of our manuals, please send your comments to:

[tecdoc@phoenixcontact.com](mailto:tecdoc@phoenixcontact.com)



PHOENIX CONTACT GmbH & Co. KG  
Flachmarktstraße 8  
32825 Blomberg, Germany  
Phone: +49 5235 3-00  
Fax: +49 5235 3-41200  
E-mail: [info@phoenixcontact.com](mailto:info@phoenixcontact.com) **phoe-**  
**nixcontact.com**